

**End of Life Plan
For
Alaris S2040
Alaris S2050
Alaris S2060w
Alaris S2070
Alaris S2080w**

Compositional Analysis

This compositional analysis applies to the Kodak Scan Mate i11xx product family. The following table identifies the location of materials that need special treatment by recyclers.

Material of concern	Present in part?	Describe Specific Component and/or location
External Battery	no	
Internal Battery	no	
Asbestos	no	
Backlighting lamps	no	
Beryllium Oxide	no	
Other forms of Beryllium	no	
Cadmium	no	
Capacitors with PCB's	no	
Capacitors with substances of concern and height > 25 mm, diameter > 25 mm or proportionately similar volume	no	
Chromium VI	no	
Gas discharge lamps	no	
Lead	yes	Meets RoHS restrictions - however has components with exemptions; steel shaft, optical glass, wafer - high temp solder, Plug Adapter (copper alloy), gear in motor (copper alloy)
Liquid Crystal Displays with a surface area > 100cm ²	no	
Mercury	no	
Plastic containing brominated flame retardants	yes	meets RoHS restrictions

Printed Circuit Boards >10 square centimeters	yes	Main Board removal see pages 4 – 6 OCP circuit board removal see pages 7 - 9
PVC/PVDC	yes	Harness insulation, cables, connectors...
Radio-active substances	no	
Refractory ceramic fibers	no	
Compartments / units / parts under pressure	no	
Compartments / units / contain liquids	no	
Compartments / units / contain gasses	no	
Compartments / units / contain "Hidden" mechanical springs or other equivalent parts	no	
Lasers	no	

Circuit Board Locations

1.0 Main Circuit Board – removal.

1.1 Remove output tray assembly

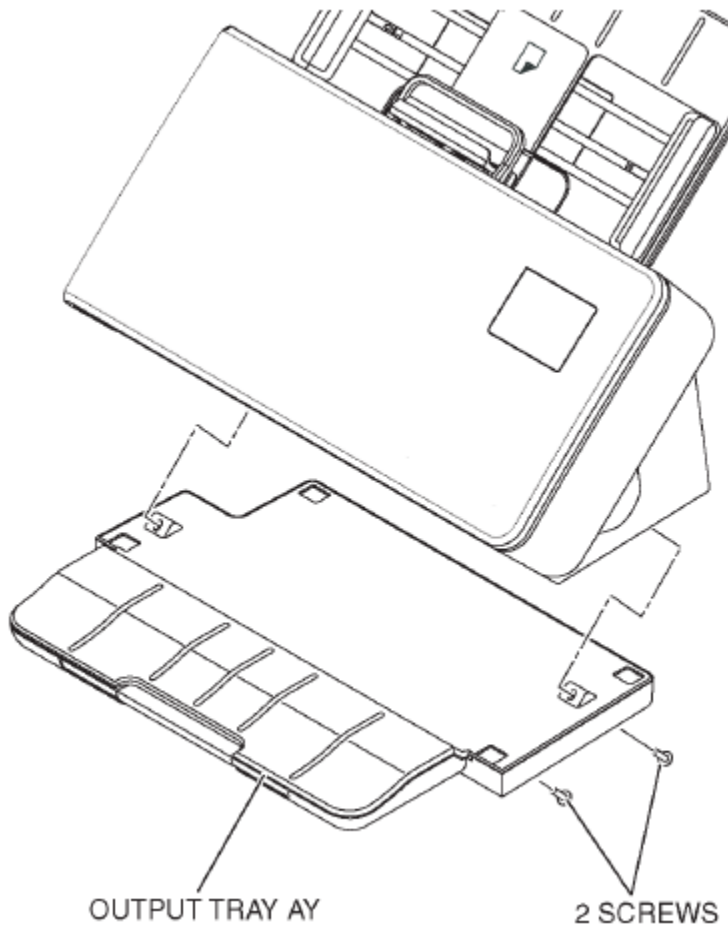

[1] Remove:

- 2 SCREWS
- OUTPUT TRAY AY

1.2 Remove Base Cover

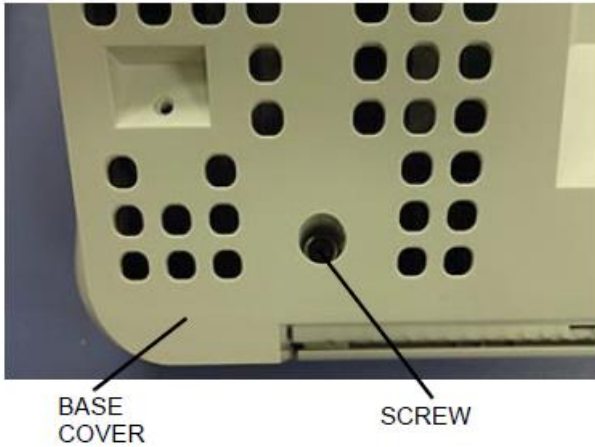

[1] Remove the SCREW from the bottom of the BASE COVER.



[2] Turn the SCANNER over, then grip the LATCH and open the POD.

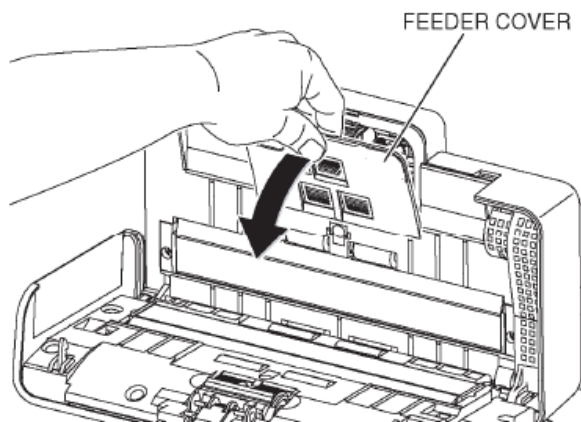

[3] Remove the FEEDER COVER.

Caution

- Use caution when removing the COVER to avoid damaging the PAPER PRESENT SENSOR (not shown).
- The URGING ROLLER will be loose, and may fall out of the SCANNER when you remove the COVER.

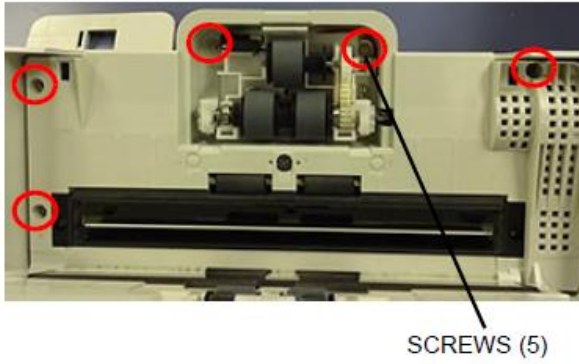

[4] Remove 5 SCREWS.

[5] Turn the SCANNER over, and remove the BASE COVER.

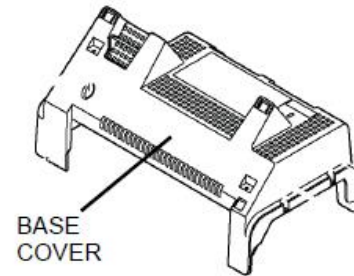

1.3 Remove circuit board

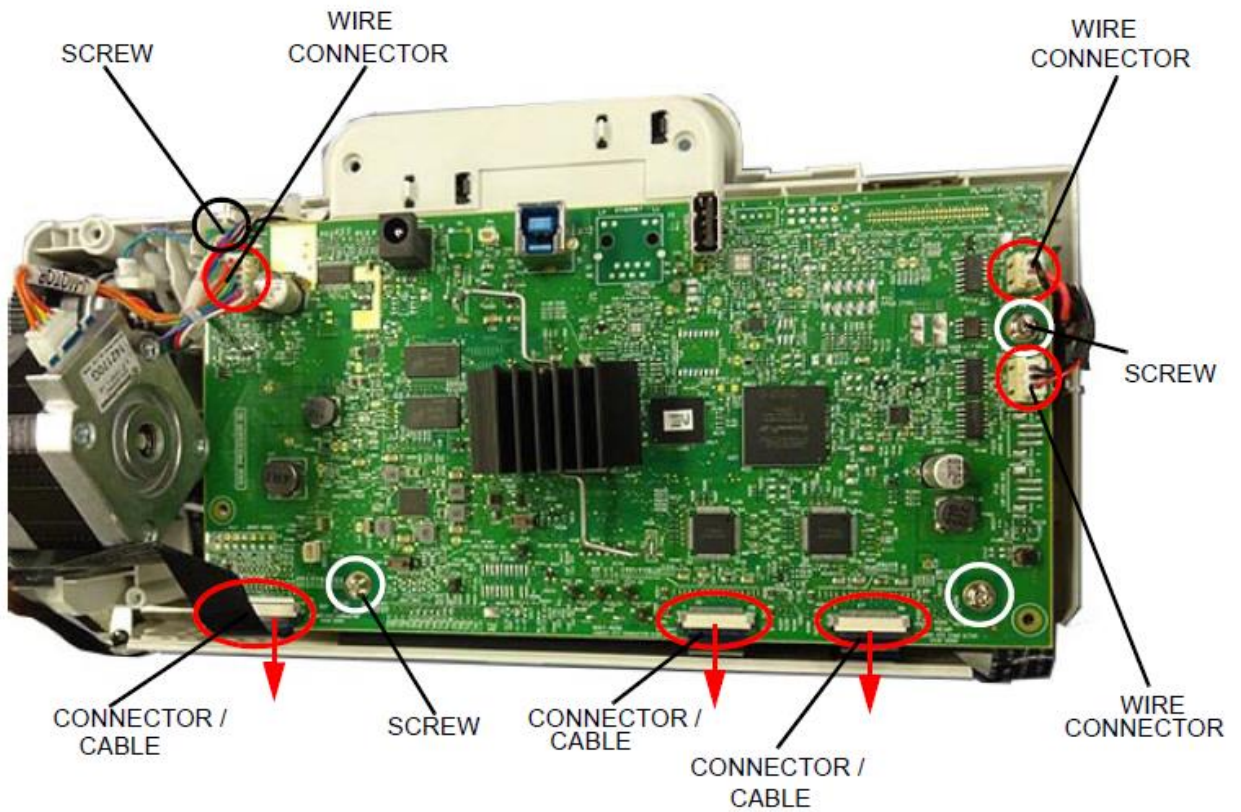

[1] Disconnect the CABLES and WIRES.

(a) Move the CONNECTORS for the three RIBBON CABLES out to unlock them, then remove the CABLES.

(b) Pull up on the three WHITE CONNECTORS to disconnect the WIRES.

[2] Remove 4 *Phillips* SCREWS, then remove the BOARD.

2.0 Remove Operator Control Panel (OCP) circuit board

2.1 Open Scanner by releasing the latch



[1] Grip the LATCH and open the POD.

2.2 Separate the POD Cover Assembly

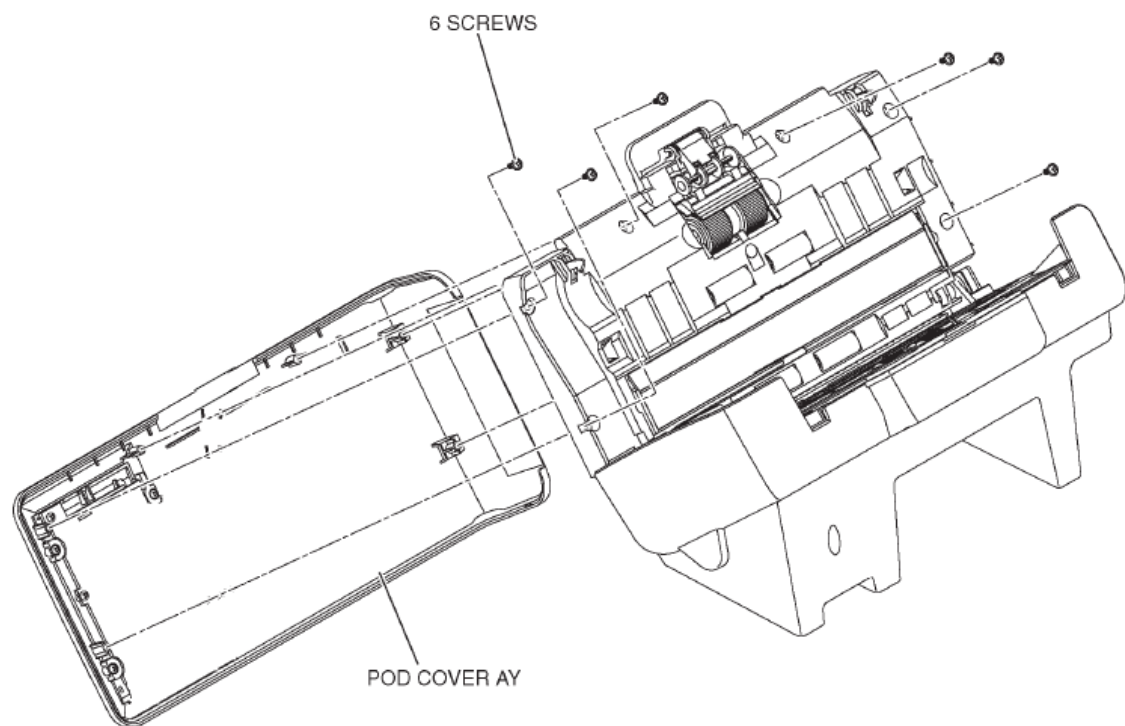

[2] Remove:

- 6 SCREWS
- POD COVER AY

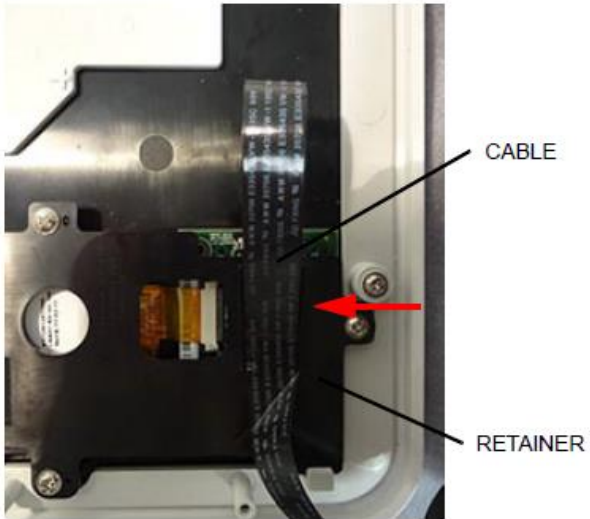

[3] Gently release the CABLE from the RETAINER; it is taped to the RETAINER.

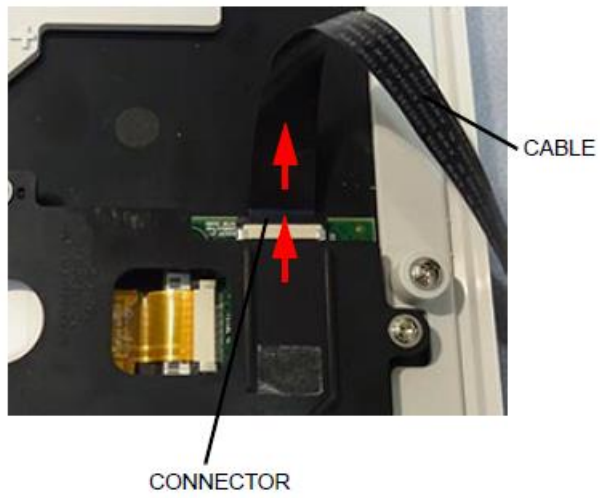

[4] Move the lock on the CONNECTOR out, then remove the CABLE.

2.3 Remove screws as shown, remove cover, disconnect OCP board from OCP assembly, remove OCP circuit board.

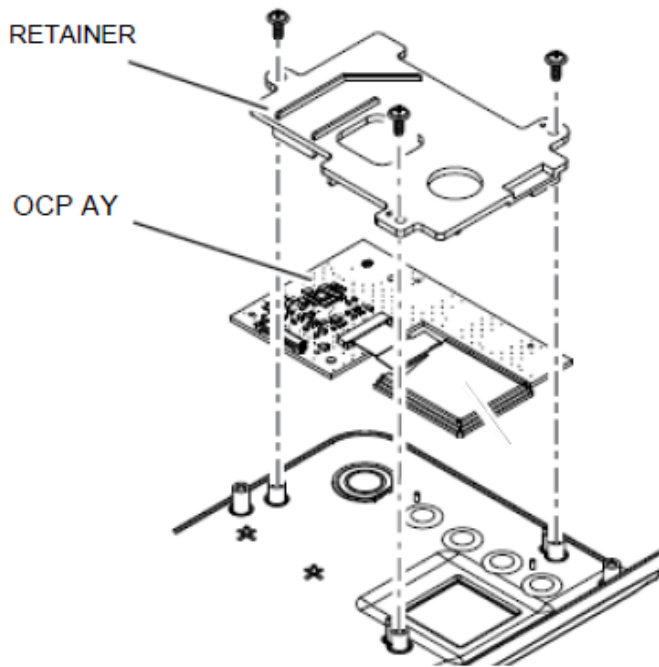

[1] Remove:

- 3 SCREWS
- RETAINER
- OCP AY (includes PCBA)

EOL Strategy

The product EOL strategy will be based on market needs, regulations, financial impact, etc. For example, the WEEE Directive in the European Union requires that a collection and treatment infrastructure is in place to manage our products at end-of-life. This obligation will be met through membership in a variety of governmental and industry-led collection schemes, as well as Kodak Alaris initiated strategies developed specifically for Kodak Alaris products. Strategies such as re-use, re-conditioning, strip and salvage, responsible disposal, etc. can vary by region and change with time.

Regulatory Requirements

The hazardous materials that are contained within this product need to be handled in compliance with the local requirements when discarded by the final user and sent for end-of-life treatment.

For recycler processes; substances, preparations, and components may be removed manually, mechanically, or chemically, metallurgically with the result that hazardous substances, preparation, components are contained in an identifiable waste stream or identifiable part of a waste stream at the end of the treatment process.

- LCDs (liquid crystal displays) must be processed by vendors capable of and experienced in recovering mercury in backlights.
- PC (printed circuit) boards must be processed by a smelter (or other thermal process) capable of and experienced in recovering precious metals (gold and so forth) and heavy metals (lead and so forth) for reuse or by a chemical recovery process. Circuit components may be extracted for reuse prior to smelting.
- Plastics should be recycled for use in new products, components and materials, as substitutes for other raw materials, or recycled in another beneficial manner. When recycling is not economically practical, plastics should be processed for energy recovery at a facility that is designed to control and monitor emissions from the process. See section 14.9 for related information.
- Printing supplies collected as part of hardware recycling (for example, a print cartridge present in a printer at the time of its collection): Original HP printer cartridges must be processed using the HP Inkjet cartridge and LaserJet toner cartridge return and recycling programs in countries where HP programs are available. All other print supplies must be recycled or disposed of in an environmentally responsible manner compliant with applicable laws and regulations.
- Metal (other than in PC boards): Acceptable processing includes liberation of metal items (manually or mechanically), volume reduction for transport (shredding, baling, and so forth), and refining by smelters or foundries (or similar) for the purpose of preparing the metal for reuse. To maximize recycling rates, sending whole products to a smelter is not authorized without approval from HP and demonstration that the smelter is capable of capturing all of the following for reuse: copper, precious metals (such as gold and silver); steel and aluminum; and, for CRT devices, lead.
- Incineration: If lead-bearing electronic components (such as circuit boards), batteries, polyvinyl chloride (PVC) plastics, mercury lamps, or any material classified as hazardous waste under applicable regulations are disposed of by incineration, the incinerator must meet 99.99% destruction removal efficiency (DRE) for all regulated hazardous contaminants and 99.9999% DRE for dioxins.

The following regulations/directives apply to these products.

WEEE

Equipment Labeling Plans

As per WEEE requirements the equipment is labeled with the dustbin symbol.

Information for Customers and Treatment Facilities

When the last user wishes to discard this product, the information that will guide the customer's action will be available on-line. The disposal information will be made available to the recycler through instructions via Kodak Alaris website.

Information provided to the user in the User Manual includes the meaning of the dustbin symbol, instructions not to dispose as unsorted municipal waste, available collection system and their role in contributing to WEEE goals and potential environmental and health effects as a result of the presence of hazardous substances.