

**Kodak** alaris

**Kodak**

S2000/2000w Series Scanners

User's Guide



## 3rd Party Licenses

This software is based in part on the work of the Independent JPEG Group

Copyright (C)2009-2013 D. R. Commander. All Rights Reserved.

Redistribution and use in source and binary forms, with or without modification, are permitted provided that the following conditions are met:

- Redistributions of source code must retain the above copyright notice, this list of conditions and the following disclaimer.
- Redistributions in binary form must reproduce the above copyright notice, this list of conditions and the following disclaimer in the documentation and/or other materials provided with the distribution.
- Neither the name of the libjpeg-turbo Project nor the names of its contributors may be used to endorse or promote products derived from this software without specific prior written permission.

THIS SOFTWARE IS PROVIDED BY THE COPYRIGHT HOLDERS AND CONTRIBUTORS "AS IS", AND ANY EXPRESS OR IMPLIED WARRANTIES, INCLUDING, BUT NOT LIMITED TO, THE IMPLIED WARRANTIES OF MERCHANTABILITY AND FITNESS FOR A PARTICULAR PURPOSE ARE DISCLAIMED. IN NO EVENT SHALL THE COPYRIGHT HOLDERS OR CONTRIBUTORS BE LIABLE FOR ANY DIRECT, INDIRECT, INCIDENTAL, SPECIAL, EXEMPLARY, OR CONSEQUENTIAL DAMAGES (INCLUDING, BUT NOT LIMITED TO, PROCUREMENT OF SUBSTITUTE GOODS OR SERVICES; LOSS OF USE, DATA, OR PROFITS; OR BUSINESS INTERRUPTION) HOWEVER CAUSED AND ON ANY THEORY OF LIABILITY, WHETHER IN CONTRACT, STRICT LIABILITY, OR TORT (INCLUDING NEGLIGENCE OR OTHERWISE) ARISING IN ANY WAY OUT OF THE USE OF THIS SOFTWARE, EVEN IF ADVISED OF THE POSSIBILITY OF SUCH DAMAGE.

---

# Contents

- Safety .....v
  - User Precautions .....v
  - Acoustic emission .....v
  
- 1 Overview .....1
  - Scanner models .....1
    - Kodak S2060w/S2080w Scanners* .....1
    - Kodak S2040/S2050/S2070 Scanners* .....2
  - Scanner Specifications .....2
  - Illustrations in this guide .....2
  - Supporting documentation .....3
  - Accessories .....3
  - Scanner components .....4
    - Front view .....4
    - Back view .....6
    - Underside view .....7
    - Inside view .....8
  
- 2 Installation .....9
  - Unboxing the scanner .....9
  - Setting up your scanner .....9
    - Additional set up steps for S2060w/S2080w .....10
    - Install ferrite core (Ethernet only for S2060w/S2080w) .....11
  - Install driver software .....12
  - Verify scanner's firmware .....13
  - Update scanner's firmware .....14
    - Computer with driver software installed .....14
    - Web Browser .....15
  - Available *Kodak Scanning Software* .....16
    - Smart Touch .....16
    - Capture Pro LE .....16
  
- 3 Scanning .....17
  - Basic scanning .....17
    - Scanner controls .....17
    - Getting your scanner ready to scan .....18
    - Getting your pages ready to scan .....18
  - Scanning Applications .....19
    - Initial scan with an *Kodak* scanning application .....19
    - Sharing the S2060w/S2080w scanner among multiple PCs .....20
    - Restricting use of the S2060w/S2080w scanner to one PC .....22
    - Other scanning applications .....22

Scanner display and buttons:	
S2040/S2050/S2070 scanners .....	23
Ready .....	23
Scanning .....	23
Waiting .....	24
Pause .....	24
Document handling .....	24
Scanner settings .....	25
Scanner display and buttons:	
S2060w/S2080w scanners .....	25
Conventions in the S2000w display screens .....	25
Ready .....	26
Scanning .....	27
Waiting .....	27
Pause .....	27
Document handling .....	28
Scanner settings .....	28
Paper handling challenges and solutions .....	29
Input tray capacity .....	29
Preparing documents for scanning .....	29
Settings for reliable feeding .....	31
Active Feeding .....	31
Enhanced Separation .....	31
Mixed paper .....	31
Enhanced stacking, to maintain order in output stack .....	32
Lightweight paper .....	32
NCR paper .....	32
Scanning small items .....	32
Long paper .....	33
Fragile or oversize paper .....	34
Handle with care .....	34
Handle with extra care .....	35
Oversize paper .....	35
Multifeeds .....	36
Detecting multifeeds during scanning .....	36
If scanner is stopping when paper is not multified .....	36
Disabling multifeed detection for special input pages .....	36
If you still have trouble .....	37
Improving image quality .....	37
Recommended settings .....	37
Other Perfect Page settings .....	37
Turning the scanner off .....	38
“Wake up” actions .....	38
From off .....	38
From standby/sleep .....	38
4 Maintenance .....	39
Scanner meters .....	39
Opening the scanner cover .....	40

---

Cleaning procedures .....	40
Clean in this order .....	41
Running a transport cleaning sheet .....	41
Cleaning the separation roller .....	42
Cleaning the feed rollers .....	44
Cleaning the transport rollers .....	45
Cleaning the imaging area .....	46
Replacement procedures .....	46
Replacing the separation roller .....	47
Replacing the pre-separation pad .....	48
Replacing the urging roller tire .....	49
Replacing the feed roller .....	50
Supplies and Consumables .....	51
Customer Replaceable Parts and Accessories .....	51
Updates .....	52
5 Troubleshooting .....	53
Scanner error indicators .....	53
Problem solving .....	53
Scanner exception handling .....	53
Self-help for problems .....	54
Calibrations .....	55
Contacting Technical Support .....	56
Appendix A Regulatory Information .....	57
<b>Environmental information</b> .....	<b>57</b>
European Union .....	57
EMC Statements for S2000 Series Scanners: .....	59
EMC and Wireless Regulatory Statements for S2000w Series Scanners: .....	60
Appendix B Warranty — US and Canada only .....	65



---

# Safety

## User Precautions

- Place the scanner on a sturdy, level work surface capable of supporting 3.2 kg (7 lbs).
- Do not install the scanner in a location subject to dust, humidity or steam. This may cause electrical shock or a fire. Only use the scanner and power supply indoors in a dry location.
- Make sure the electrical power outlet is located within 1.52 meters (5 feet) of the scanner and is easily accessible in case of an emergency.
- Plug the power adapter securely into the wall outlet. Failure to do so may cause electrical shock or fire.
- Do not damage, knot, cut or modify the power cord. This may cause electrical shock or fire.
- Use only the AC adapter that is supplied with the scanner. Do not use the scanner's AC adapter with any other product. This may cause electrical shock or fire.
- Do not use the scanner if it becomes inordinately hot, has a strange odor, emits smoke, or makes unfamiliar noises. Immediately stop the scanner and disconnect the power cord from the power outlet. Contact Technical Support.
- Do not disassemble or modify the scanner or the AC power adapter.
- Do not move the scanner with the power cord and interface cable attached. This may cause damage to the cord/cable. Remove the power cord from the wall outlet before moving the scanner.
- Follow the Kodak Alaris recommended cleaning procedures. Do not use air, liquid or gas spray cleaners. These cleaners displace dust, dirt and debris to another location within the scanner, which may cause the scanner to malfunction.
- Safety Data Sheets (SDS) for chemical products are available on the Kodak Alaris website at: [www.alarisworld.com/go/ehs](http://www.alarisworld.com/go/ehs). When accessing the SDS from the website, you will be required to provide the catalog number. See "Supplies and Consumables" on page 51 for supplies and catalog numbers.
- This device is not intended for use in the direct field of view at visual display workplaces. To avoid incommoding reflexions at visual display workplaces this device must not be placed in the direct field of view.

## Acoustic emission

Maschinenlärminformationsverordnung – 3, GSGV  
Der arbeitsplatzbezogene Emissionswert beträgt <70 dB(A).

[Machine Noise Information Ordinance — 3, GSGV  
The operator-position noise emission value is <70 dB(A).]





---

# 1 Overview

## Scanner models

This User's Guide provides information and procedures for using and maintaining the *Kodak S2040, S2050, S2060w, S2070, and S2080w* Scanners.

The *Kodak S2000/S2000w* Series Scanners are compact, duplex color document scanners perfect for personal and workgroup use. They scan 40-80 A4/letter size pages per minute (200/300 dpi black and white, grayscale, and color). The input tray holds 80 pages. The dual LED indirect illumination provides excellent image quality.

The S2000/S2000w Series Scanners have *built-in* embedded image processing capabilities, to process images within the scanner electronics. This feature reduces dependency on the PC processor, so a lower specification PC can be used to support these scanners.

All these scanner models are entitled to use a freely downloadable *Kodak* scanning application, available at the support page for your model, for example [www.alarisworld.com/go/S2080wsupport](http://www.alarisworld.com/go/S2080wsupport). *Kodak* scanning applications allow you to scan your documents and send them to various destinations with the touch of a button, then search for and view your digitized documents based on different search criteria.

The S2000/S2000w scanners may also be used with other PC-based scanning applications by means of the TWAIN or ISIS driver interface.

The S2000/S2000w Series Scanners also support the following flatbed accessories:

- *Kodak A3 Size Flatbed* (not available for model S2040)
- *Kodak Passport Flatbed*
- *Kodak Integrated A4/Legal Size Flatbed*

### **Kodak S2060w/S2080w Scanners**



The S2000w model scanners offer wired (USB or Ethernet) or wireless connection to your network. One scanner can therefore be accessed by more than one PC on the network.

The S2000w scanners let you monitor and direct the scanner using a 3.5 inch display touch screen on the scanner itself.

The S2060w model scans at 60 pages per minute and the S2080w at 80 pages per minute (duplex scanning of portrait oriented pages, 200/300 dpi, in black and white, grayscale, or color).

## Kodak S2040/S2050/S2070 Scanners

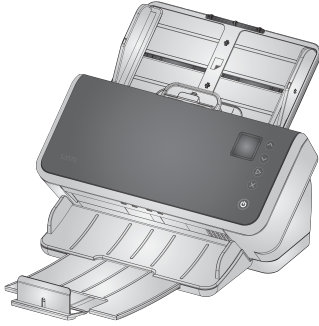

The S2040, S2050, and S2070 scanners connect to your PC over a USB cable. They offer a 1.5 inch display screen and buttons so you can monitor and direct the scanner from the scanner itself.

The S2040 models scan A4/letter-size documents at 40 pages per minute, the S2050 model at 50 pages per minute, and the S2070 at 70 pages per minute (duplex scanning of portrait oriented pages, 200/300 dpi, in black and white, grayscale, or color).

## Scanner Specifications

Current scanner specifications may be found here:

[www.alarisworld.com/go/S2000](http://www.alarisworld.com/go/S2000)

[www.alarisworld.com/go/S2000w](http://www.alarisworld.com/go/S2000w)

Look for a link to specifications for your specific scanner model.

NOTE: Specifications on the web site refer to the latest scanner driver and firmware versions.

## Illustrations in this guide

This User's Guide provides information and procedures for all *Kodak S2000/S2000w Series Scanners*. The illustrations in this guide show either the *Kodak S2080w Scanner* or the *Kodak S2070 Scanner*; your model may look slightly different from a specific illustration. The information in this guide applies to all S2000/S2000w scanner models unless otherwise noted.

## Supporting documentation

In addition to this User's Guide, the following documentation is also available:

- **Installation Guide** — quick visual steps for installing your scanner.
- **Reference Guide** — easy visual steps for cleaning your scanner. Download this guide and keep it close to the scanner.
- **User Guides for Kodak scanning applications** — information on how to use freely downloadable *Kodak* scanning applications.
- **Help for TWAIN and ISIS** — information on how to use the TWAIN Datasource and ISIS Driver is available in Help. Use the F1 key after you have selected a driver and the user interface appears. This information is also available in PDF on the support page for your scanner model.
- **Videos** — some operations are explained using videos.
- The manuals and videos for your scanner model can be found on the Support page for your model:

**S2040:** [www.alarisworld.com/go/S2040support](http://www.alarisworld.com/go/S2040support)

**S2050:** [www.alarisworld.com/go/S2050support](http://www.alarisworld.com/go/S2050support)

**S2070:** [www.alarisworld.com/go/S2070support](http://www.alarisworld.com/go/S2070support)

**S2060w:** [www.alarisworld.com/go/S2060wsupport](http://www.alarisworld.com/go/S2060wsupport)

**S2080w:** [www.alarisworld.com/go/S2080wsupport](http://www.alarisworld.com/go/S2080wsupport)

## Accessories

Accessories, including flatbeds of different sizes and a sleeve for scanning delicate or oversize pages, can be found on the following support pages:

**S2040/S2050/S2070:** [www.alarisworld.com/go/S2000support](http://www.alarisworld.com/go/S2000support)

**S2060w/S2080w:** [www.alarisworld.com/go/S2000wsupport](http://www.alarisworld.com/go/S2000wsupport)

# Scanner components

## Front view

This illustration shows the S2040/S2050/S2070 model scanners. The scanner screen and buttons differ in the S2060w/S2080w models, as illustrated below.

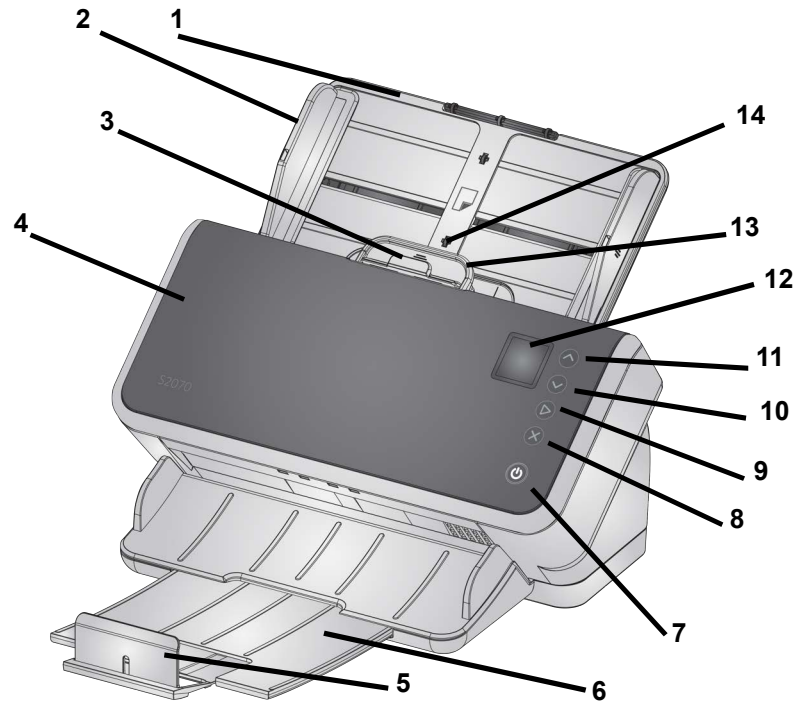

- 1 Input tray** — the input tray holds up to 80 pages of A4 80 g/m<sup>2</sup> paper and can be extended to accommodate pages up to legal size (14 inches/355.6 mm). In long document mode it will accept pages up to 118 inches/3 m. (Long documents need additional support to hold them up so they don't droop off the back of the input tray. See "Getting your scanner ready to scan" on page 18 for illustration of input tray extension)
- 2 Side guides** — the side guides can be moved in and out to accommodate the size of pages you are scanning. Side guides may be locked in place for letter size or A4 size paper. See "Getting your scanner ready to scan" on page 18.
- 3 Gap release** — allows you to manually adjust the space between the feed roller and separation roller for pages that require special handling (e.g. thick paper, envelopes, hard cards). When using the gap release, pull the gap release out to feed special pages. When finished, push the gap release back in place.
- 4 Scanner cover** — when opened, provides access to internal components such as the imaging area and the feed and separation rollers.
- 5 End Stop** — can be lifted up when scanning, for better stacking of output pages

NOTE: some of the items on this page refer to the illustration on the previous page.

- 6 Output tray** — collects the scanned pages. The output tray can be pulled out and extended to accommodate pages up to 35.56 cm (14 inches) in length. For longer pages, keep the end stop down.
- 7 Power button** — touch this button to turn the scanner on or off. The power button is lighted when the scanner is powered on. The lighted button blinks when a situation requires your attention: for example, to close the scanner cover. It blinks more slowly when the scanner is in low power mode.
- 8 X button** — this multi-function button can **End** or **Pause** a scanning job, **Cancel** out of a menu, or (on the S2040/S2050/S2070 scanners) display a **Menu**. Its function varies at different times during scanner operation.
- 9 Play / Select button** — (S2040/S2050/S2070 scanners) starts scanning and launches the scanning application; in some menus, it will **Select** the indicated menu option.
- 10 & 11 Down and Up buttons** — (S2040/S2050/S2070 scanners) allow you to scroll through a display too long to fit on the scanner screen. Touch the Up or Down buttons to scroll.

Front view — S2060w and S2080w models

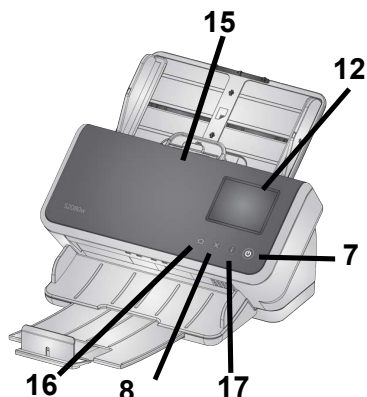

- 12 Scanner screen** — for the S2040/S2050/S2070 scanners, color graphic display of scanner information; for the S2060w/ 2080W scanners, a larger touch screen with color graphic display of scanner information and controls. For all models, the screen provides access for *Kodak* scanning applications that allow you to initiate scanning at the scanner.

NOTE: On the S2060w/S2080w scanners, the Play, Up, and Down functions are available using the scanner touch screen.

- 13 Scanner cover release lever** — opens the scanner to allow access to the paper path for cleaning or for clearing a document jam.
- 14 ID card positioning** — for scanning one small card (such as US driver's license or other credit card sized ID cards) in landscape orientation. Refer to "Scanning small items" on page 32 for precise positioning of credit card.
- 15 Close scanner cover by pressing here.**
- 16 Home button** — (S2060w/S2080w scanners) returns you to the scanner home display. For *Kodak* scanning applications, you will see the list of scanning setups. For applications that must initiate scanning at the PC, you will see the Ready screen.
- 17 i button** — (S2060w/S2080w scanners) takes you to a display of scanner information.

## Back view

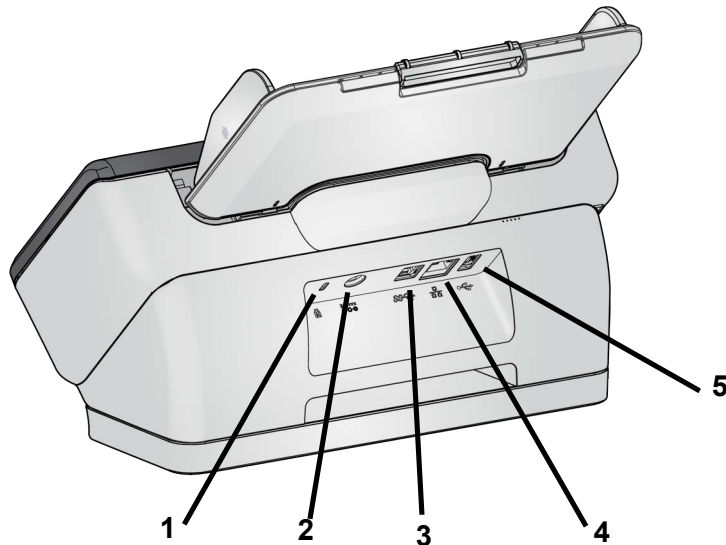

- 1 Security lock port** — allows you to connect a security lock to the scanner. You can purchase a standard security lock at an office supply store.
- 2 Power port** — connects the power supply to the scanner.
- 3 USB 3.1 Super Speed port** — connects the scanner to the PC.
- 4 Ethernet port** — (not available in S2040/S2050/S2070 models) connects the scanner to the network.
- 5 USB 2.0 High Speed port** — connects the scanner to a *Kodak* integrated flatbed.

## Underside view

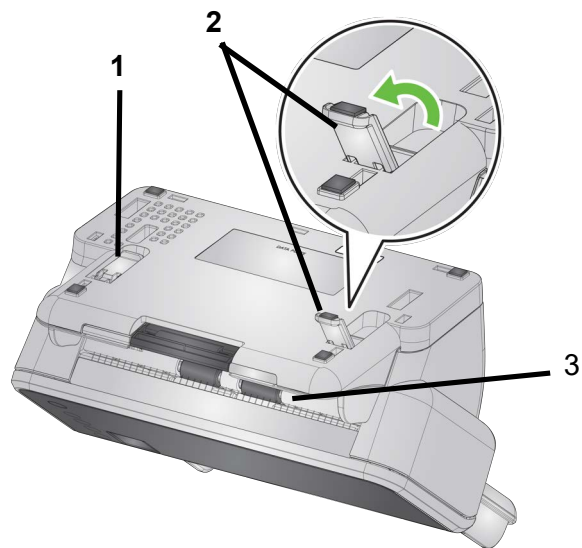

**1 Tilt stand leg** — recessed into scanner base (not provided with S2040).

**2 Tilt stand leg** — fully extended to lift front edge of scanner — assists output of long pages (not provided with S2040).

NOTE: In operation, either recess or fully extend both legs.

**3 Transport rollers** — six transport rollers should be cleaned from inside the scanner (see “Inside view” on page 8); these two should be cleaned from the underside.

## Inside view

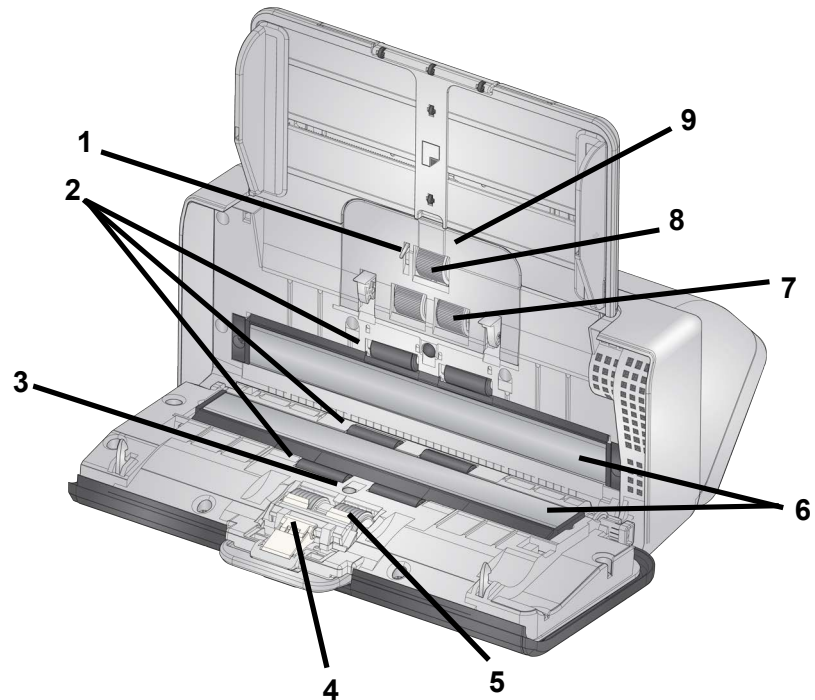

- 1 **Paper present sensor** — detects the presence of paper in the input tray.
- 2 **Transport rollers** — (three pairs) these six rollers, plus the two visible on the “Underside view” on page 7, help move paper smoothly through the scanner.
- 3 **Multifeed and intelligent document protection sensor** — detects multifeed pages and pages that are crinkling in the scanner.
- 4 **Pre-separation pad** — helps to feed one page at a time from the input tray.
- 5 **Separation roller** — provides smooth page feeding and separation of various sizes, thicknesses and textures of input pages.
- 6 **Image glass** — the area of the scanner where imaging takes place.
- 7 **Feed roller** — provides smooth feeding and separation of various sizes, thicknesses and textures of pages.
- 8 **Urging roller** — pulls next page into scanner from the input tray.
- 9 **Feed roller cover** — provides access to feed rollers.



---

## 2 Installation

The following is a list of steps you will need to perform in order to get your scanner set up and connected to your computer.

1. Unbox your scanner.
2. Set up your scanner for the first time.
3. Install driver software.
4. Verify the scanner's firmware.
5. Optionally update scanner's firmware.
6. Optionally install available *Kodak* scanning software.

NOTE: When installing updates, update the driver software before updating the scanner's firmware.

If you need additional assistance with any scanner issues, go to the troubleshooting website for your scanner model:

**S2040/S2050/S2070:**

[www.alarisworld.com/go/S2000-troubleshooting](http://www.alarisworld.com/go/S2000-troubleshooting)

**S2060w/S2080w:**

[www.alarisworld.com/go/S2000w-troubleshooting](http://www.alarisworld.com/go/S2000w-troubleshooting)

### Unboxing the scanner

Follow these steps to unbox your scanner and get it ready to be set up.

1. Open the scanner box.
2. Remove all the contents from the scanner box.
3. Remove all the shipping tape from the scanner.
4. Find the *Installation Guide* and open it.
5. Verify the contents of scanner box. (Refer to left panel of the *Installation Guide*.)

### Setting up your scanner

Follow these steps from the *Installation Guide*.

1. Install the input tray.
2. Attach the correct AC plug adapter to the power supply. Attach the power supply to the scanner, and then to a power outlet.

NOTE: Do not attach any other cables to the scanner at this time (e.g. USB). You will be instructed when to do that, at the proper time.

3. Turn the scanner on by pressing the power button  on the front of the scanner.



## Additional set up steps for S2060w/S2080w

In addition to the above steps from the *Installation Guide*, you will need to configure the scanner's network settings using the scanner's display.

The Language selection screen will be displayed, unless the scanner was previously configured. If the scanner was previously configured, you can reset the scanner so it will start this set up again:

- Press  on the scanner's display to open the Settings menu.
- Scroll down to "Reset", then press it.
- Follow any prompts.

NOTE: The Settings menu can also be used to change individual network and power settings.

To navigate through the scanner's display set-up screens, make your selection(s) and then press the right arrow  to go to the next screen/step. To go back to the previous screen/step, press the left arrow .

There are three main set up paths:

- "Setup Wizard" – Allows you to use the scanner's display to set up the scanner for three common configurations. This is a good choice for a small company or small group. The choices are:
  - Wired Network: USB is also available, but Wireless access is turned off/disabled.
  - Wireless Network: USB is also available, but the wired connection is turned off/disabled.
  - USB Only: both Wireless or Wired access is turned off/disabled.
- "Scan EasySetup Document" – Allows you to scan a previously created EasySetup configuration document. This is more suited for a large installation where a system administrator can set up the parameters for uniform use across the company or multiple sites.

To create an EasySetup configuration document, go to <https://easyssetup.alarisworld.com> and follow the instructions. You can then print the PDF for your use, or e-mail the PDF to your users.
- "Advanced" – Allows you to have full control over all the network settings. This is appropriate when the "Setup Wizard" combinations are not sufficient and EasySetup is not desired.

NOTE: You can cancel out of the network set up process by pressing the  button on the scanner. If you cancel, the scanner will use the default network settings: Wired Network is turned on/enabled in automatic (DHCP) mode, Wireless is turned on/enabled in Access Point mode, and USB is available.

## Install ferrite core (Ethernet only for S2060w/S2080w)

If you are using an Ethernet cable, you will want to install the provided ferrite core. Without a properly attached ferrite core, the scanner may cause interference to nearby wireless devices.

1. Open the ferrite core that came with the scanner.

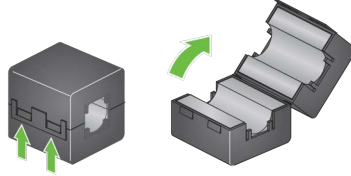

2. Wrap the Ethernet cable around the ferrite core as shown. Place it approximately 3 in./7.6 cm from the end of the Ethernet cable that will be plugged into the scanner.

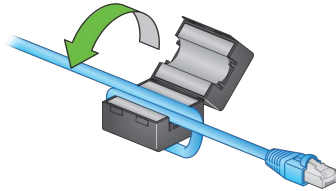

3. Close the ferrite core, being careful not to pinch the Ethernet cable.

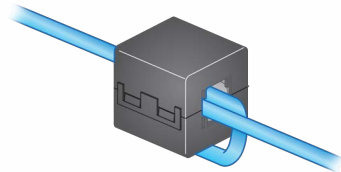

## Install driver software

While the driver software on the provided disc will work with your scanner, to assure you have the latest software, please download it from the scanner's product support website.

You should only use the disc from the scanner box if your PC does not have access to the internet or you are unable to download executable files.

NOTE: The disc only contains driver software for Windows Operating Systems. You must go to the scanner's product support website (below) to get drivers for other Operating Systems.

1. If your computer has access to the internet, obtain the driver software from scanner's product website:

-Go to your scanner's product support website:

**S2040/S2050/S2070:**

[www.alarisworld.com/go/S2000install](http://www.alarisworld.com/go/S2000install)

**S2060w/S2080w:**

[www.alarisworld.com/go/S2000winstall](http://www.alarisworld.com/go/S2000winstall)

-Scroll to the driver section that matches your computer's Operating System.

-Select the file to download. For Windows, "Windows – EXE". For Linux, pick the package that is appropriate for your distribution.

-Run the driver software installer.

2. If you are unable to download from the scanner's product website, and your computer is running a Windows Operating System:

-Place the disc from the scanner box into the disc drive of your computer.

-If your computer does not automatically start the installer, browse to the disc and run set\_up.exe.

3. Follow the steps of the "Kodak S2000 Scanners" driver software installation. Be sure to follow the 'Typical' installation in order for your computer to be properly connected to your scanner and to verify the scanner is working.

## Verify scanner's firmware

Follow these steps to see if your scanner's firmware needs updating.

1. Determine your scanner's firmware version by doing the following on the scanner:

### **S2040/S2050/S2070:**

-Make sure your scanner is turned on and in the Ready screen.

-Press the **X** button to display the Settings menu on the scanner's display.

-Make sure 'Information' is selected/highlighted. You can use the arrow buttons to change the highlighted selection.

-Press the **▷** button to display the scanner's information. The scanner's current firmware version number is shown after 'Firmware:'. It will be a six-digit number.

-Press the **X** button to exit the Settings menu.

-Press the **X** button to return to the Ready screen.

### **S2060w/S2080w Scanner:**

-Make sure your scanner is turned on and in the Ready screen.

-Press the **i** button to display the Information menu on the scanner's display.

-Scroll down to get the scanner's current firmware version number. It is shown after 'Firmware:'. It will be a six-digit number.

-Press the **X** button to exit the Information menu and return to the Ready screen.

2. Determine the version of the firmware that is on the scanner's product website:

-Go to your scanner's product support website:

### **S2040/S2050/S2070:**

[www.alarisworld.com/go/S2000install](http://www.alarisworld.com/go/S2000install)

### **S2060w/S2080w:**

[www.alarisworld.com/go/S2000winstall](http://www.alarisworld.com/go/S2000winstall)

-Scroll to the Firmware section that matches your scanner's model name.

-If the version is not shown, then click the 'Release Notes' link.

3. If the firmware version number on the website is higher than the scanner's firmware version, then you should update the firmware version.

## Update scanner's firmware

Use one of the following methods to update your scanner's firmware:

- Computer with driver software installed – Use this option when the computer already has the driver software installed and it is connected to/can access the scanner.
- Web Browser – You have a S2060w or S2080w that has at least one network connection turned on/enabled, and you have a computer that is on the same network as the scanner.

### Computer with driver software installed

Follow these steps to update your scanner's firmware from a computer that already has the driver software installed.

The scanner must be connected/available to the computer. If you can scan from the computer, then it can be used to update the scanner's firmware.

1. Go to your scanner's product support website:

**S2040/S2050/S2070:**

[www.alarisworld.com/go/S2000install](http://www.alarisworld.com/go/S2000install)

**S2060w/S2080w:**

[www.alarisworld.com/go/S2000winstall](http://www.alarisworld.com/go/S2000winstall)

2. Scroll to the Firmware section that matches your scanner's model name.
3. Download the firmware installer that matches your computer's Operating System.
4. Make sure your scanner is turned on, is connected/available to your computer and not showing any errors.
5. Run the firmware installer.
6. Follow the steps of the firmware installer.

## Web Browser

Follow these steps to update your scanner's firmware via the scanner's internal web page. You will do this using the web browser from a computer that is on the same network as the scanner.

NOTE: This is only available for S2060w and S2080w scanners that have at least one network connection turned on/enabled. Networking is turned on/enabled by default.

1. Go to your scanner's product support website:

[www.alarisworld.com/go/S2000winstall](http://www.alarisworld.com/go/S2000winstall)

2. Scroll to the Firmware section that matches your scanner's model name.
3. Select the "Web Browser (.sig)" file to download.
4. Make sure your scanner is turned on and available on the network and not showing any errors.
5. Obtain the scanner's network IP Address:

-Press the **i** button to display the Information menu on the scanner's display.

-Scroll down to the appropriate IP Address. If you will connect via the wired network, then use the IP Address under "Wired Address:". If you will connect via the wireless network, then use "Wireless Address:".

-Press the **X** button to exit the Information menu.

6. Open a web browser on the computer and do the following within the web browser:

-Enter the scanner's network IP Address to get to the scanner's internal web page.

-Click the 'Support' tab.

-Click the "UPDATE SCANNER FIRMWARE" button; it is in the lower left corner.

-Click the 'Browse' button.

-Navigate the folder, on the computer, that you downloaded the \*.sig file to.

-Select the \*.sig.

-Click the "Start Firmware Update" button.

-Wait for the firmware update to complete. It may take several minutes.

## Available *Kodak* Scanning Software

Easy-to-use *Kodak* scanning applications have been customized to work with your scanner (see descriptions below). They can be downloaded from your scanner's product support website:

**S2040:** [www.alarisworld.com/go/S2040support](http://www.alarisworld.com/go/S2040support)

**S2050:** [www.alarisworld.com/go/S2050support](http://www.alarisworld.com/go/S2050support)

**S2070:** [www.alarisworld.com/go/S2070support](http://www.alarisworld.com/go/S2070support)

**S2060w:** [www.alarisworld.com/go/S2060wsupport](http://www.alarisworld.com/go/S2060wsupport)

**S2080w:** [www.alarisworld.com/go/S2080wsupport](http://www.alarisworld.com/go/S2080wsupport)

Training information can be found at:

[www.alarisworld.com/go/scanningsoftware](http://www.alarisworld.com/go/scanningsoftware)

### Smart Touch

Easy to use application that allows you to scan your paper documents, then search for and view the digitized documents.

### Capture Pro LE

Application allows you to quickly scan large, high resolution, or uncompressed documents. Capture, edit and output batches to repository or other applications.



---

# 3 Scanning

## Basic scanning

### Scanner controls

#### S2040/2050/S2070 Scanner

The cover of the S2040/S2050/S2070 Scanner contains a screen with a 1.5" diagonal color display, and five buttons.

The power button  is always active and is used to turn the scanner on and off. The function of the other four buttons may change depending on the scanner screen display.

Refer to "Scanner display and buttons: S2040/S2050/S2070 scanners" on page 23 for more information.



#### S2060w/S2080w Scanner





The cover of the S2060w/S2080w Scanner contains a touch screen with a 3.5" diagonal color display and four buttons.

The power button  is always active and is used to turn the scanner on and off.

Refer to "Scanner display and buttons: S2060w/S2080w scanners" on page 25 for more information.



NOTE:

- Throughout this chapter, the , ,  and  button illustrations represent the buttons on your scanner. For S2040/S2050/S2070 model scanners, the buttons are on the scanner cover.
- For S2060w/S2080w model scanners, the button functions are accomplished on the touch screen. An  button is also provided on the scanner cover.

## Getting your scanner ready to scan

1. Be sure the scanner is on and ready to scan (power button on and not blinking).
2. Move the side guides in or out to fit the size of pages you are scanning. If scanning letter or A4 size paper, the side guides may be restricted to the maximum width of the paper using the switch in the inset below on right. The switch is shown in the letter size position. See “Preparing documents for scanning” step number 6 on page 30.

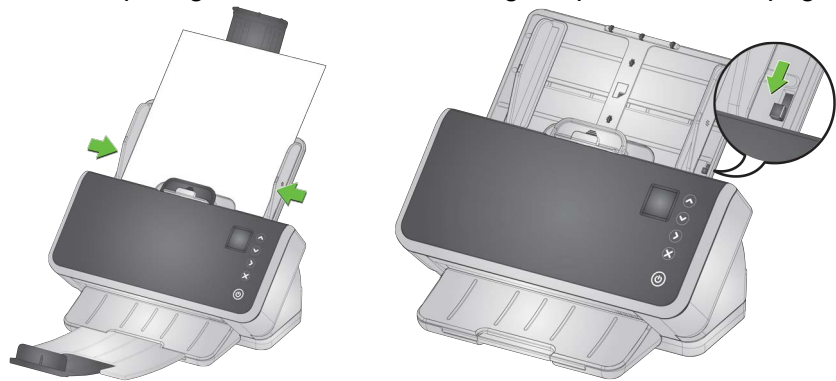

3. If necessary, adjust the input and output trays for the length of your pages. The output tray can be extended to accommodate pages up to 35.56 cm (14 inches) in length. An end stop is available to assist output page stacking. Lift this end stop as needed for scanning pages up to 14 in/35.6 cm. Keep the end stop *down* when scanning longer pages. See “Long paper” on page 33.

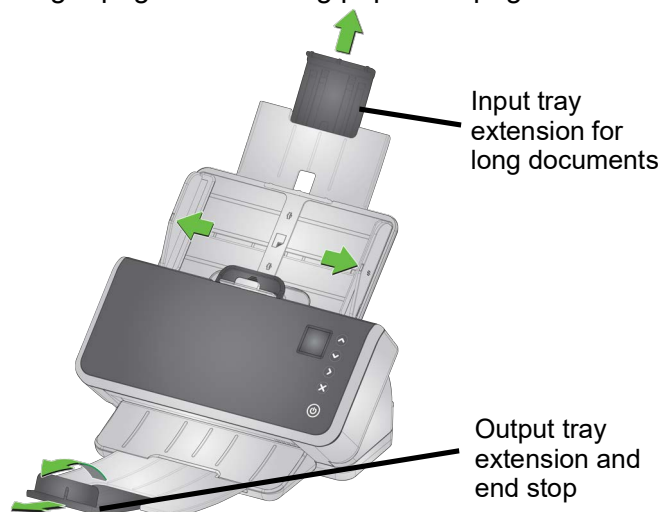

## Getting your pages ready to scan

Refer to the following sections for detailed help:

- “Input tray capacity” on page 29
- “Preparing documents for scanning” on page 29

Later sections of this chapter provide advice on how to scan hard cards, batches of mixed size paper, NCR paper, etc.



## Scanning Applications

### Initial scan with a *Kodak* scanning application

*Kodak* scanning applications are available for download with your scanner purchase and will allow you to quickly and easily perform common scanning tasks, such as:

- create a searchable PDF of a printed report
- scan an invoice and store it with your other invoices
- scan a photo to add to a presentation

If you installed a *Kodak* scanning application, the following steps show you how to create an output file of your document. For more information about the scanning options enabled by *Kodak* scanning applications, refer to the documentation for your specific application.

1. Put paper in the scanner input tray, face down and lead edge first
2. Using the  or  buttons on the S2040/S2050/S2070 scanners, or the scroll bar on the S2060w/S2080w scanners, scroll up or down until *Color PDF* appears on the scanner screen. (If you are using Capture Pro, choose *Scan to PDF*.) The front and back of your pages will be scanned and produce a color PDF file as output.
3. On the S2040/S2050/S2070 scanner, press the **Play / Select**  button. On the S2060w/S2080w scanner, press on the scanner screen to begin scanning.

The document will be scanned. When you output it, the PDF file with your image(s) will be sent to a folder. Refer to the documentation for your *Kodak* scanning application to see details of the folder location.

## Sharing the S2060w/S2080w scanner among multiple PCs

NOTE: This section is relevant only for scanning with button-enabled applications which allow scanning to be initiated at the scanner (requires a *Kodak* scanning application).

By default, the S2000w scanners (the network scanners):

- will allow any PC or mobile device to connect over an enabled wired or wireless connection.
- are in multiple PC mode. Multiple PC mode enables unlimited access by PCs using TWAIN, ISIS or WIA drivers over a network connection. Up to 10 PCs with button-enabled applications installed will be displayed on the scanner screen. Limiting scanner access to a single PC is explained in “Restricting use of the S2060w/S2080w scanner to one PC” on page 22.

Setup for sharing the network scanner among PCs:

1. The S2060w or S2080w scanner is configured for wireless or wired connections.
2. Several PCs or laptops install the S2000w scanner driver and install a *Kodak* scanning application.
3. The users may optionally add a 4-digit numeric network security PIN to their *Kodak* scanning application configuration.
4. The users may set up custom activities in a *Kodak* scanning application, based on their needs. For example, users may set up an activity to scan to their own One Drive account.

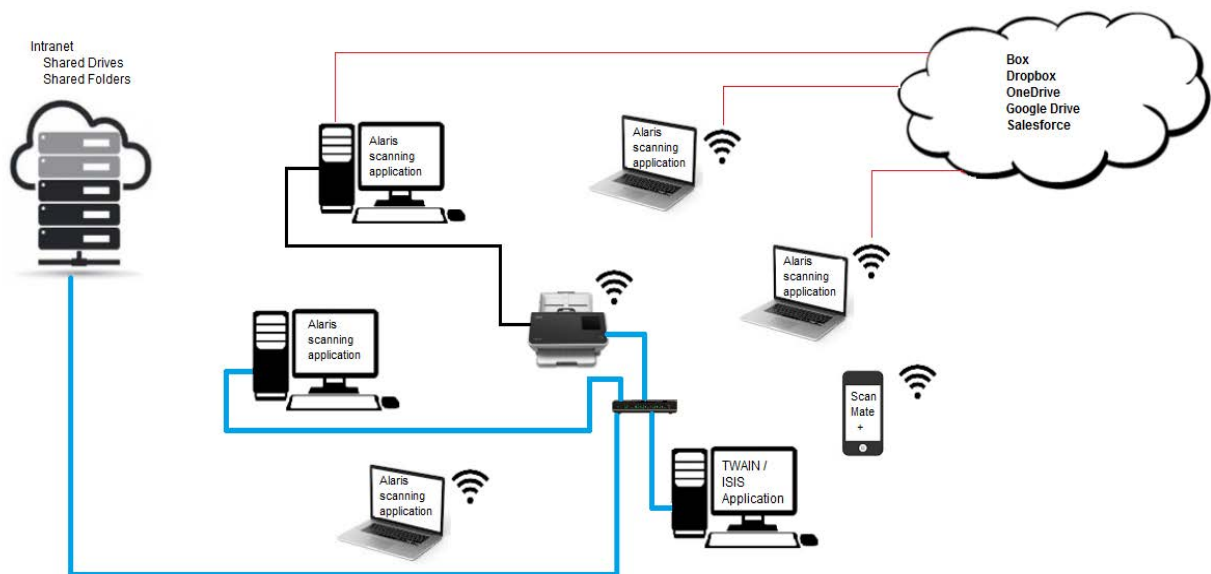

Usage Example:

1. The S2060w or S2080w Scanner is turned on.
2. The three PCs that are on the network connect to the S2000w scanner. The logged in user name and account picture are displayed on the scanner screen list of users.

3. Users with laptops come into the office and power on their laptops. The laptop user's user name and account picture are displayed on the scanner as each one comes on the network.
4. A PC user needs to send a document to their One Drive.
  - The user walks up to the scanner and selects their user name from the list of users on the scanner screen.
  - The user enters their network security PIN when prompted by the scanner.
  - The scanner displays the user's *Kodak* scanning application activities on the scanner screen.
  - The user places a document in the scanner and chooses their One Drive activity from the list.
  - The scanner scans the document.
  - When the last image is read from the scanner, the *Kodak* scanning application processes the document on the user's PC and sends the document to the user's One Drive account.
  - The user presses the Home button on the scanner to log out, so the scanner is available for the next user. (If a user forgets to log out, their access will time out.)
5. A laptop user powers their laptop off to go to an off-site meeting. The S2000w scanner notes that the laptop is no longer connected and removes the user name and account picture from the scanner's user list.
6. A user at a PC needs to scan with scanning software that uses the TWAIN or ISIS driver.
  - The user launches their scanning application and selects the S2000w scanner.
  - The S2000w scanner shows that the scanner is currently in use by that user. No other users will be able to use the scanner until that user's scanning is completed.
  - The user places paper in the S2000w scanner and starts the scan.
  - The document is scanned by the user's scanning software. The scanner is then free for other users to connect.
7. A user needs to scan from an application that uses the Kodak Alaris Web API.
  - The user launches their scanning application and selects the S2000w scanner.
  - The S2000w scanner shows that the scanner is currently in use by that user. No other users will be able to use the scanner until that user's scanning is completed.
  - The user places paper in the S2000w scanner and starts the scan.
  - The document is scanned by the user's scanning software. The

scanner is then free for other users to connect.

## Restricting use of the S2060w/S2080w scanner to one PC

The S2000w scanners may be set up to limit access by PCs using TWAIN, ISIS, or WIA drivers over a network connection. By enabling *Single PC Mode* in the S2000w display screen (Settings menu) or the scanner's embedded web site, only the "owning PC" can connect using the scanner drivers. The "owning PC" is the first PC to connect (using the connect scanner utility) after the scanner is placed into Single PC Mode. The scanner screen will display the owning PCs activities directly (for example; activities, tasks, button shortcuts).

When in Single PC Mode, *Kodak* button-enabled applications will not allow user selection at the scanner screen.

A user can still access a Single PC Mode scanner from a mobile device.

If you want to limit use of your scanner by others but still access it yourself from a mobile device, you should set up Single PC Mode.

NOTE: Single PC Mode does *not* prevent access to the scanner from applications enabled by the Kodak Alaris Web API. Access to the scanner's embedded web server is not limited in Single PC Mode.

In Single PC Mode, use the scanner in this way:

1. Log in on the PC that "owns" the scanner.
2. Load your pages into the input tray.
3. At the touch screen, scroll to the desired activity name (e.g. *License*). Choosing the name will initiate scanning.
4. Retrieve your pages from the output tray.
5. Access your images on the PC using your *Kodak* scanning application, or the file system.

## Other scanning applications

*Kodak* offers scanning options, such as Capture Pro Software and Info Input Solution. These applications have other capabilities that can improve your data capture, processing, and retrieval. Contact your reseller for more information, or go to <http://www.alarisworld.com/go/software>.

You may already have a different scanning application that accesses your scanner using its TWAIN or ISIS driver.

In addition, you may access the Scan Validation Tool. The Scan Validation Tool offers access to the TWAIN and ISIS driver user interface. It is intended to be used for diagnostic purposes, not for normal scanning.

## Scanner display and buttons: S2040/S2050/S2070 scanners

The scanner screen display is used in different ways during the different scanner states:



- Ready
- Scanning
- Pause
- Settings
- Waiting

When the scanner has gone into Energy Star sleep, the scanner screen is dark.

### Ready

When the scanner is ready to start scanning, the scanner screen tells you what the scanner is prepared to do (e.g. by displaying the current activity for your *Kodak* scanning application) and which of the scanner buttons are available.

When the scanner is ready, you can:



- See the scan setting name — if you are using a *Kodak* scanning application, you will see activity names.
- Scroll up and down the list of predefined scanning settings, using the up and down scrolling buttons. The up button  will count up to the next scan setting number, i.e. from setting 1 to setting 2.
- Start scanning, using the Play button. 

If you want to view or adjust scanner capabilities, from the Ready state you can go to the Settings menu, using the  button.

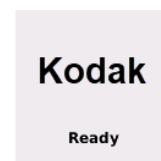
NOTE: If you are not using a scanning application that enables scanning from the scanner, you will see this display on the scanner screen. From here you can access Settings using the  button.



### Scanning

When the scanner is scanning, the scanner screen shows the number of pages scanned since the last time you stopped  scanning. While scanning you can use the  button, to pause scanning or to end scanning and complete this document.

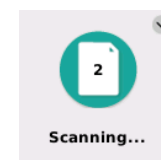

To ignore multifeed warnings for a document, press and hold the Play button  while that document is transporting through the machine. For example, if you are scanning mail, you can hold down the Play button when the envelope passes through the scanner.

If you have set up special settings for your pages, the display during scanning will have an indicator of the special handling: for instance scanning with multifeed detection disabled.

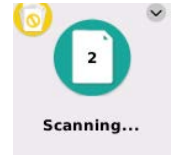

## Waiting

Sometimes the scanner will wait for you to take some action:

- A feeding situation such as a multifeed waits for you to take some action. The scanner screen indicates your options.
- Restart required — power the scanner off, wait 5 seconds, then power it on.
- Scanner cover open — close the cover.

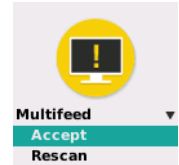

## Pause

Use the **X** button to pause during scanning. Pause allows you to change some settings dynamically.

## Document handling

The setting for document **Handling** determines how the scanner transports pages through the scanner. It affects how pages are fed into the scanner, how fast they move through the scanner, and how they are placed in the output tray. An enhanced handling option can improve output stacking. You may find it helpful for mixed page sizes, lightweight paper, paper with some static, or paper with some curl.

Special document handling can be set up for your job using the driver. During scanning, you can adjust document handling using the scanner screen:

- First pause the scanner. Press the **X** button to pause scanning. The scanner screen indicates the pause; the scanner waits for you to resume or stop scanning.
- While the scanner is paused, press the down arrow to get to the document handling menu. Use the arrow buttons to select **Normal**, **Improved**, or **Best**:
  - **Normal**: No additional handling is performed. Use **Normal** when all documents are similar in size.
  - **Improved**: Aids in controlling how the documents are stacked/ordered in the output tray for mixed document sets. **Improved** should work for the majority of mixed sets.
  - **Best**: When your document set contains great variability in size, this option provides the best control of how pages are stacked in the output tray.
- Press Play / Select **▶** to resume scanning with the handling method you selected.

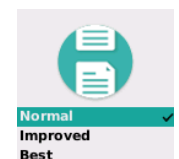
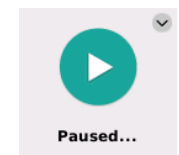



## Scanner settings

When you are not scanning you can reach the Settings menu with the **X** button. Settings offers these options:

- *Information* gives you a few key facts about your scanner, such as firmware version.
- *Calibrations* lets you calibrate the multifeed detection system.

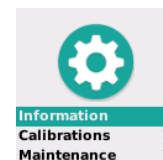

NOTE: Multifeed calibration is needed rarely and should be done only if a Technical Support person instructs you to calibrate, or if the scanner has been moved to a location at a high elevation.

- *Maintenance* gives you the ability to record performance of important scanner maintenance, such as scanner cleaning.

## Scanner display and buttons: S2060w/S2080w scanners

### Conventions in the S2000w display screens

The Status bar  on the display screen shows connections for the scanner: USB, wired network, wireless network, or wireless directly.

The Back  button goes back once.

The Next  button advances to the next screen.

The menu  icon leads to network and power Settings.

This icon  beside a menu option means you have a choice of “on” or “off” for the option:

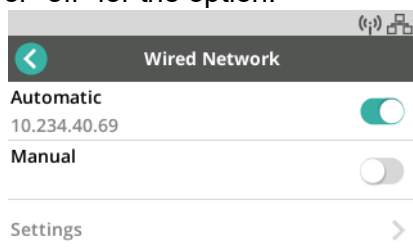

The colored icon means “on” and the gray icon means “off.”

A check mark means the option is selected:

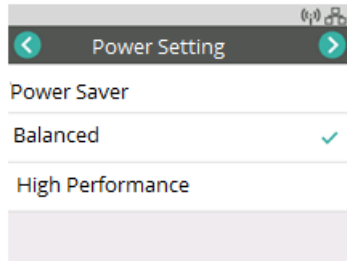

When more options are available than the screen can display, a scroll bar is provided:



## Ready

Several displays are possible when the scanner is ready to start scanning:

- Choose yourself from the list of possible users.
- Enter your identification number.
- Choose the scan setting or activity to use for scanning.
- The generic Ready display (shown here) if your scanning application does not allow you to initiate scanning at the scanner.

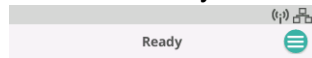

## Kodak

NOTE: If another user is scanning, the display screen will indicate that the scanner is in use by someone else.

## Scanning

When you are scanning, the display shows the page count for this scan session and whether any special settings are enabled. It also allows you to pause scanning or end the job.

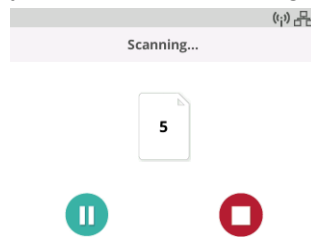

## Waiting

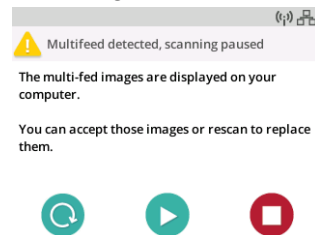

Sometimes the scanner will wait for you to take some action:

- A feeding situation such as a multifeed waits for you to take some action. The scanner screen indicates your options: rescan, accept the images and continue scanning, or end scanning.



- Restart required — power the scanner off, wait 5 seconds, then power it on.
- Scanner cover open — close the cover.

## Pause

Pause the scanner with the **X** button or Pause  on the scanner screen. The scanner screen indicates the pause; the scanner waits for you to either resume, or stop scanning **X** or .

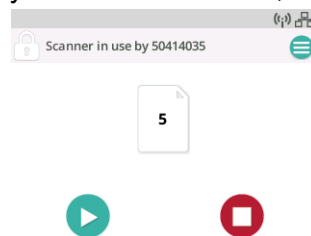

If you pause the scanner, options are available from the menu. For instance, if you know an envelope will enter the scanner and you don't want a multifeed reported, you can pause scanning, choose the menu icon , and disable multifeed detection during the pause.

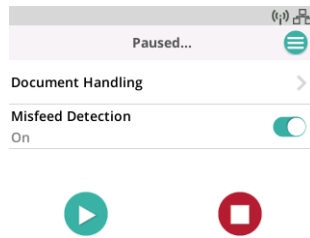

## Document handling

Document handling options and when to use them are explained in “Document handling” on page 24.



## Scanner settings

From the Settings screen you can review or change the network and power choices for the scanner.

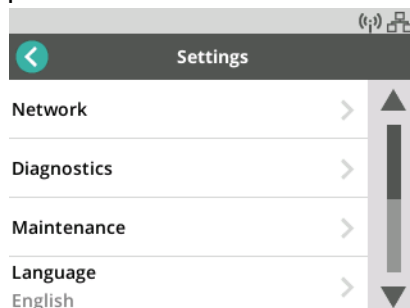

Also in Settings you can:

- Record Maintenance events such as when the scanner was cleaned or parts replaced.
- Choose the language for the display.
- Choose whether the user from only one PC or users from multiple PCs can initiate scanning at the scanner.
- Access diagnostics.

# Paper handling challenges and solutions

## Input tray capacity

Paper weight and size determine how much paper can feed smoothly from the input tray. The input tray will accommodate 80 pages of 20 lb (75 g/m<sup>2</sup>) paper. Even if you use thinner paper, do not load more than 80 sheets:

Paper weight — g/m <sup>2</sup>	Paper weight — lb	For A4, letter, or shorter size	For legal size
27 - 80	7.2 - 21	80 sheets	50 sheets
> 80 - 104	> 21 - 28	60 sheets	50 sheets
> 104 - 157	> 28 - 42	40 sheets	30 sheets
> 157 - 256	> 42 - 69	25 sheets	20 sheets
> 256 - 413	> 69 - 110	15 sheets	10 sheets

## Preparing documents for scanning

The pages being scanned and physical setup of the scanner affect how smoothly your input pages will feed into the scanner and stack after passing through the scanner. Standard paper size pages feed easily.

Be sure your pages conform to size, weight, and type of documents that the scanner can handle. See the scanner specifications for your scanner model, at

**S2040/S2050/S2070:** [www.alarisworld.com/go/S2000](http://www.alarisworld.com/go/S2000)

**S2060w/S2080w:** [www.alarisworld.com/go/S2000w](http://www.alarisworld.com/go/S2000w)

Follow these “good practices” tips to ensure good feeding:

1. Remove all staples and paper clips from the pages. Staples and paper clips may damage the scanner and your pages.
2. All inks and correction fluids on the paper must be dry before scanning is started.
3. If your pages stick together, they may have trouble feeding one by one. Fan the pages to help them separate, before putting them in the input tray. It can be helpful to fan them in two directions if they stick tightly together (e.g. because of static or because they are very smooth).
4. After fanning, straighten the stack of pages. If the pages have mixed sizes, straighten just at the edge that will lead them into the scanner. If the pages are all the same size, straighten them first on a side edge and then on the lead edge.
5. Place the pages centered in the input tray, between the side guides. Position the front side of your pages face down against the input tray and the top of the pages into the input tray, lead edge first. Extend the input tray so it supports the input stack.

6. Slide the side guides so they touch the sides of your input stack. If your paper is standard letter or A4 size, the input tray has a switch to restrict the side guides from opening wider, as shown.



7. Extend the output tray so it is longer than the input stack by about 1/2 in/1 cm. Raise the end stop of the output tray, if the paper is shorter than 14 in/35 cm.
8. For pages that are difficult to feed or separate, feather the lead edges of the stack, as shown. Hold the back of the stack and bend the stack so the lead edges of the bottom documents are forward of the top documents. Maintain this shape in the stack when you place the pages into the input tray.



9. Some paper types can affect feeding and separation performance:
  - Thermal papers
  - Coated papers
  - Glued edge papers
  - Perforated pages
  - Carbonless paper
  - Pre-folded paper
  - Papers with static charge
  - Photographs (glossy)
  - Rough textured paper
  - Previously stapled documents

You may need to experiment with these tips and with active feeding (see “Mixed paper” on page 31) to find the preparation steps and input stack size that work well for your documents.

## Settings for reliable feeding

### Active Feeding

Active Feeding can help to align and prepare the leading edges of small stacks (30 or fewer sheets) prior to feeding. If the document set for a typical job is smooth paper of mixed sizes, Active Feeding can help it feed reliably. To enable active feeding, refer to the TWAIN or ISIS driver help or set-up guides. Set-up guides are available on the support page for your model:

**S2040:** [www.alarisworld.com/go/S2040support](http://www.alarisworld.com/go/S2040support)

**S2050:** [www.alarisworld.com/go/S2050support](http://www.alarisworld.com/go/S2050support)

**S2070:** [www.alarisworld.com/go/S2070support](http://www.alarisworld.com/go/S2070support)

**S2060w:** [www.alarisworld.com/go/S2060wsupport](http://www.alarisworld.com/go/S2060wsupport)

**S2080w:** [www.alarisworld.com/go/S2080wsupport](http://www.alarisworld.com/go/S2080wsupport)

### Enhanced Separation

Enhanced Separation aids in reducing multifeeds at the start of scanning. This feature is *on* by default because it is recommended for all feeding applications. Page types that separate easily may feed reliably with this feature turned *off*. Turning enhanced separation *off* will allow scanning to begin slightly more quickly. To enable enhanced separation, refer to the TWAIN or ISIS driver help or set-up guides. Set-up guides are available on the support page for your model. For a list of support page links, see “Active Feeding” on page 31.

### Mixed paper

Follow the tips in “Preparing documents for scanning” on page 29, and above in “Settings for reliable feeding”. Try to stack the input paper so it is centered, side to side in the input tray. Lead edges should align or be feathered.

If you want output pages to align at the trailing edge (which can be useful when input pages are different lengths), raise the scanner on its tilt stand:

1. Tip the scanner backwards.
2. Pull the tilt stand legs down until they snap into their extended position. See “Underside view” on page 7.
3. Tip the scanner forwards until it rests on the tilt stand legs. This configuration will encourage output pages to settle against the scanner.

NOTE: Tilt stand legs are not available on the S2040.

## Enhanced stacking, to maintain order in output stack

Using the tilt stand may be especially helpful with enhanced stacking. To enable enhanced stacking, refer to the TWAIN or ISIS driver help or set-up guides. Set-up guides are available on the support page for your model. For a list of support page links, see “Active Feeding” on page 31.

## Lightweight paper

Straighten the stack of input paper, then fan pages, before placing them in the feeder, lead edge first.

Do not push lightweight paper too far into the input tray. The scanner needs to detect the pages, but pushing too far may crumple delicate paper.

For pages less than 7.2 lb/27 gm<sup>2</sup> weight, set **Active Feed** to *None* (go to the TWAIN **Settings** > **Device - Transport** tab).

## NCR paper

“No carbon required” (NCR) paper is coated with chemicals that affect the scanner rollers and can degrade scanner feeding performance. After scanning NCR paper you should clean the scanner. See “Cleaning procedures” on page 40.

## Scanning small items

If you are scanning small items such as a driver’s license or credit card — especially hard cards that are relatively thick — they should be scanned with the embossed side up and ideally one at a time. You may need to assist them by hand.

One card may be scanned first in a batch with larger pages.

Feed hard cards in landscape orientation.





## Long paper

1. Provide support to the input stack. For long paper, extend the input tray as far as possible. Give additional support to very long paper by hand, if needed.
2. Set the output tray length at the maximum. Do not raise the end stop.
3. If you gently pull the output tray past its detent, the far end will drop, which enhances stacking of long pages.



## Fragile or oversize paper

### Handle with care

If you are concerned that delicate pages might crumple as they pass through the scanner, you can enable Intelligent Document Protection. This setting will stop the scanner if it detects a page at risk. To enable Intelligent Document Protection, refer to the TWAIN or ISIS driver help or set-up guides. Set-up guides are available on the support page for your model. For a list of support page links, see “Active Feeding” on page 31.

- You may have to experiment to find the optimal setting for your specific pages, balancing care of your pages against scanning throughput.

Using gap release is another option to handle with care. Some pressure is used to separate the first (bottom) page in a stack from the rest of the stack. If you want to feed one delicate page or a photo with no pressure on it, pull up the gap release tab, put your page into the input tray, and scan it.

Return the gap release tab to its normal position for scanning a stack of pages.

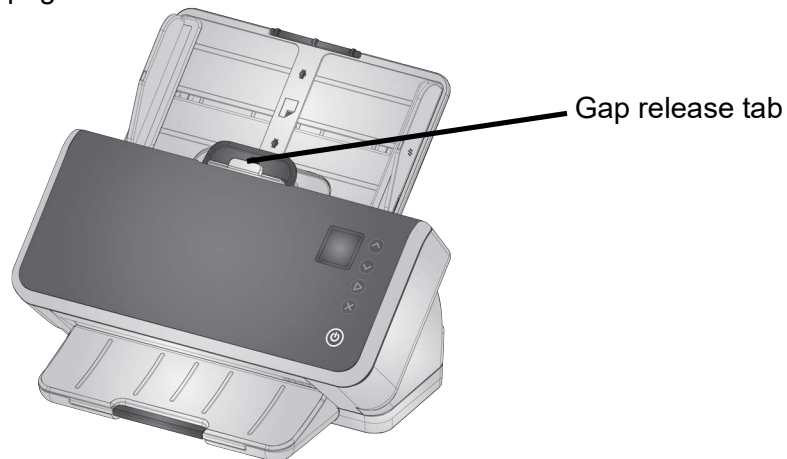

## Handle with extra care

For fragile paper that you can't risk damaging, put each page into a document sleeve (to order *Kodak* Carrier Sleeves (5 packs), refer to the link for your scanner in "Supplies and Consumables" on page 51). To enable scanning with a carrier sleeve, refer to the TWAIN or ISIS driver help or set-up guides. Set-up guides are available on the support page for your model. For a list of support page links, see "Active Feeding" on page 31. Then:

- Put the paper in the sleeve and scan.

NOTE: Intelligent Document Protection should be *off* when scanning with a carrier sleeve. See "Handle with care" above.

If you regularly scan fragile paper, you should consider adding a *Kodak* flatbed accessory. To see *Kodak* flatbed accessories available, refer to the link for your scanner in "Supplies and Consumables" on page 51.

## Oversize paper

If you want to scan paper that is wider than the input opening of the scanner but less than twice that width, you can scan it folded, in a sleeve accessory (to order *Kodak* Carrier Sleeves (5 packs), refer to the link for your scanner model in "Supplies and Consumables" on page 51). To enable scanning a folded document, refer to the TWAIN or ISIS driver help or set-up guides. Set-up guides are available on the support page for your model. For a list of support page links, see "Active Feeding" on page 31. Then:

- Fold the paper in half so it fits into the sleeve.
- Both sides of the sleeved document will be scanned, and the images will be merged into one.

## Multifeeds

A multifeed is more than one page passing through the imaging area together. It results in either one or more images not being captured, or an image that combines content from more than one page.

### Detecting multifeeds during scanning

Adjust multifeed sensitivity in your scanning application.

If a multifeed occurs when you are scanning (and interactive multifeed is set up for your job):

1. Look at the image on your PC. If the image is acceptable, choose to accept it in your scanning application or press the Play button at the scanner to resume scanning.
2. If the image is not acceptable:
  - Open the scanner cover.
  - Separate the multifeed pages and put them back at the bottom of the stack.
  - Shuffle the stack into good feeding form again.
  - Close the scanner.
  - Put stack into the input tray.
  - Choose **Rescan** at the scanner or in your scanning application. The image will be deleted and scanning will resume.

### If scanner is stopping when paper is not multifeed

Adjust multifeed sensitivity in your scanning application. Refer to the TWAIN or ISIS driver help or set-up guides. Set-up guides are available on the support page for your model. For a list of support page links, see “Active Feeding” on page 31. You may have to experiment to find the ideal setting with your types of pages.

### Disabling multifeed detection for special input pages

Your scan settings may be set to detect multifeeds. If you want to keep that normal setting, but occasionally disable it to scan an envelope or a page with paper taped to it, without stopping:

- For the S2040/S2050/S2070 scanners, press and hold the Play button while the document is transporting through the scanner.
- For the S2060w/S2080w scanners, pause scanning, then go into **Settings > Advanced** view and override multifeed detection.

## If you still have trouble

If you have tried the other suggestions in this section and still have trouble, then check the scanner:

- See “Cleaning procedures” on page 40 for how to clean the scanner. Roller cleanliness and wear affect how well pages feed.
- See “Replacement procedures” on page 46 to be sure that feed rollers, separation rollers, and pre-separation pad are installed correctly.
- See “Problem solving” on page 53 for more suggestions.

NOTE: Certain options you may select, such as feeding documents with more care or improved output stacking, will slow scanning throughput.

## Improving image quality

Your scanner is able to produce images optimized for your purpose. Here are some of the commonly used enhancements. These and more features are described in the Help system for your driver (TWAIN or ISIS). These features are set up through the driver, so your *Kodak* scanning application may be able to use them in programmed scanning profiles or settings.

## Recommended settings

Black and White Perfect Page and Color Perfect Page shortcuts in your driver provide our recommended settings for document scanning.

## Other Perfect Page settings

The following settings can improve the appearance of your images or documents:

1. Auto blank page removal: Images with little or no data can be automatically removed from output, saving manual editing and storage.
2. Hole fill: Black holes from paper punches can be changed to the background color of the image.
3. Background color smoothing: In color images, uneven image background color can be changed to a more uniform background, for a cleaner looking image.
4. Noise reduction (despeckle): Black and white images may have noise (black specks) because of uneven paper thickness. Noise reduction options can make the image look cleaner. They also have some risk of removing information from the image, so if automated data recognition is your primary purpose, noise reduction may not be a good choice.
5. Image border: To remove all background at the image border, turn on edge fill (either automatic or automatic with tears).
6. Color dropout: Unneeded form data, in one or multiple colors, can be eliminated from the image.

7. Image merge: Front and back images can be merged into one — e.g. the front and back of a check can become one image.
8. Dual stream: You can receive both a black and white and a color (or grayscale) image of the scanned page, for front, back, or both sides.

## Turning the scanner off

To turn the scanner off, touch the power button for 1 second.

NOTE: The *Power Off* energy saver feature will also turn the scanner off after an extended period of time in power saver mode. The default is 15 minutes. For the S2040/S2050/S2070 scanners you can configure this period of time using your scanning application. For the S2060w/S2080w scanners, configure on the scanner touch screen or embedded web site.

## “Wake up” actions

### From off

- Press the scanner power button. 

### From standby/sleep

Any of the following will wake the scanner from low power mode:

- Press the scanner power button.
- Put paper into the input tray.
- Use a scanning application that is connected to the scanner.
- On the S2060w/S2080w scanners, touch the scanner screen.
- Access the scanner over USB for the S2040/S2050/S2070, or on wireless network, USB, or Ethernet for S2060w/S2080w.

NOTE: PC wake-up will not wake up the scanner from either Energy Star or power off.

---

# 4 Maintenance

## Scanner meters

Your scanner has several meters with information about when to clean and replace various scanner parts. Using the meters will help to maintain image quality and scanning performance.

To see the meters display, choose Maintenance at the scanner screen. The meters display will show the tools symbol in either teal (cleaning or replacement limit not reached) or yellow (time to clean or replace):

No cleaning or replacement needed

Time to clean or to replace a part

Meter counts (scans since last cleaning or replacement)

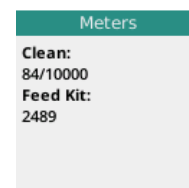
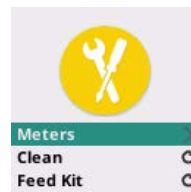
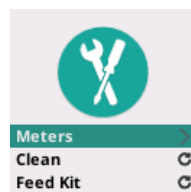

Choosing **Meters** from this screen will display the number of scans since the last cleaning or part replacement, and the number at which cleaning of the scanner or replacement of the part is needed.

-  Choosing Reset for *Clean* or *Feed Kit* will turn the count back to 0 (number of scans since the last cleaning/replacement).

**NOTE:** **Tire** replacement refers to the separation roller assembly. Feed roller tire replacement should not be needed. The feed roller assembly may be replaced if needed, though it is expected to perform well for normal life of the scanner.

## Opening the scanner cover

1. Pull the scanner cover release lever to release and open the scanner cover.



2. When you finish cleaning the scanner or replacing a part, close the scanner cover.

## Cleaning procedures

Your scanner needs to be cleaned periodically. For any of these issues you should first clean your scanner:

- your pages do not feed easily
- several pages feed at the same time
- streaks appear on your images
- pages exiting the scanner have roller/tire marks

Transport cleaning sheets, roller cleaning pads, and Staticide and Brilliantize wipes are all available for purchase from Kodak Alaris. Refer to the link for your scanner in “Supplies and Consumables” on page 51 for supplies required to clean your scanner.

**IMPORTANT:** Use only cleaners recommended by Kodak Alaris. Do not use household cleaners. Do not use alcohol or products containing alcohol.

*Allow surfaces to cool to ambient temperature before cleaning. Do not use cleaners on hot surfaces.*

*Use adequate ventilation. Do not use cleaners in confined areas.*

*After cleaning, allow rollers to dry before resuming scanning.*



## Clean in this order

1. Before cleaning, disconnect the electrical power.
2. Use a transport cleaning sheet several times to remove residue from the rollers. This cleaning technique is simpler for you and helps preserve the rollers. See “Running a transport cleaning sheet”.
3. If the rollers do not come clean with the transport cleaning sheet, then clean them with roller cleaning pads. Refer to “Cleaning the separation roller” and “Cleaning the feed rollers”.
4. When the rollers are clean, clean the imaging area. Refer to “Cleaning the imaging area”.
5. Wash your hands with soap and water after performing maintenance procedures.
6. Go to *Maintenance* on your scanner screen display and choose **Clean > Reset**. See “Scanner meters” on page 39.

## Running a transport cleaning sheet

1. Remove the wrapping from the Transport Cleaning Sheet.
2. Adjust the side guides to fit the cleaning sheet.
3. Place a transport cleaning sheet in the input tray (adhesive side up, toward you) in portrait orientation.
4. Using your scanning application, scan the transport cleaning sheet.
5. After the transport cleaning sheet is scanned, turn it over (adhesive side down, toward the input tray) and scan it again.
6. Open the scanner cover and wipe the imaging area with a lint-free cloth.
7. Close the scanner cover.
8. Scan a few pages. Check that ink or toner from the rollers is not visible on scanned pages or on images.
9. If necessary, repeat this procedure.

NOTE: When a transport cleaning sheet gets very dirty, discard it and use a new one. If the sheet is not dirty, put it back into its wrapping to save for re-use.

## Cleaning the separation roller

The separation roller should be removed from the scanner for best cleaning results.

1. Open the scanner cover.
2. Remove the pre-separation pad by grasping it and pulling it straight out.



3. Grasp the separation roller and pull it straight out.



4. Wipe the separation roller tires with a roller cleaning pad. If there are grooves in the tires, wipe in the direction of the grooves. The tires on your model may look different than the tires in this illustration.



5. Inspect the separation roller.

If the separation roller tires show signs of wear or damage, replace the separation roller assembly. See “Replacement procedures” on page 46 for more information.

6. Reinstall the separation roller by aligning the tab with the slot and snapping it into position.



7. Reinstall the pre-separation pad by aligning the slots with the holes on the pre-separation pad and snapping it into place.



8. Close the scanner cover.

## Cleaning the feed rollers

1. Open the scanner cover.
2. Grasp the top edge of the feed roller cover and lift it out of position.

**NOTE:** Be careful not to damage the paper present sensor when removing the feed roller cover or cleaning around the feed roller.

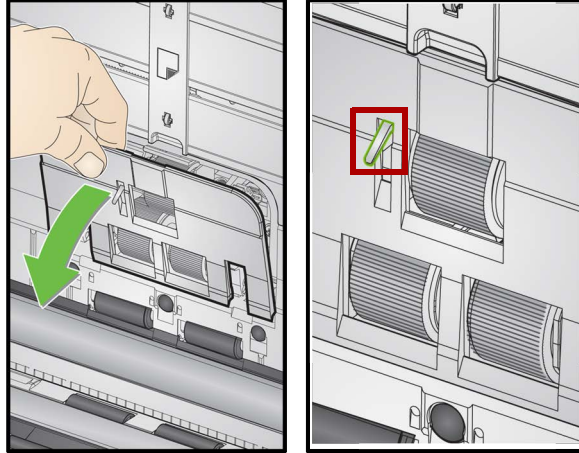

3. Remove the urging roller, then clean it with a roller cleaning pad.

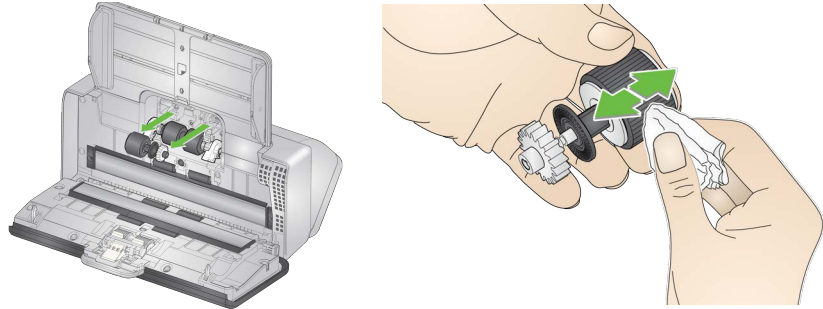

4. Replace the urging roller.
5. Clean the lower feed roller tires without removing them. Rotate the roller in place with one hand and wipe with the other, using a roller cleaning pad.

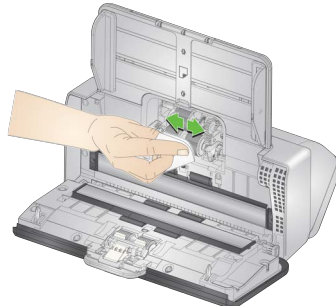

6. Inspect the feed rollers. If the feed roller tires show signs of wear or damage, replace the feed roller. See “Replacement procedures” on page 46 for more information.

7. Look at the cavity in which the feed rollers are housed. If it seems to contain excessive dust, wipe out the dust with a folded roller cleaning pad. You may also use a vacuum to clean this area.

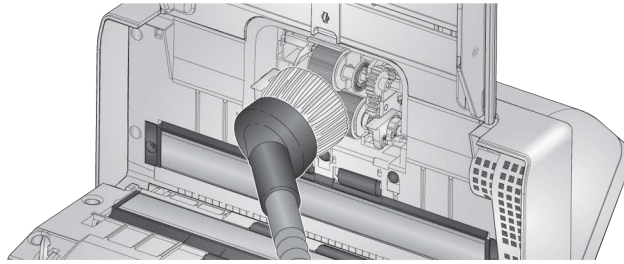

8. Reinstall the feed roller cover by positioning it around the paper present sensor (step 1), aligning the bottom edge of the cover with the scanner (step 2), and pushing it back into position until it snaps into place (step 3).

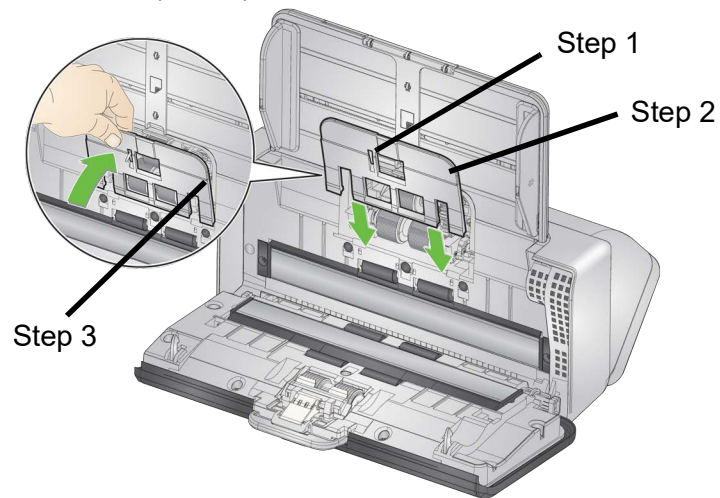

## Cleaning the transport rollers

Use a roller cleaning pad to clean the transport rollers. Six are accessible from inside the scanner (shown below). Two are more easily reached from the underside. See "Underside view" on page 7.



## Cleaning the imaging area

1. Wipe the upper and lower imaging area using a Brillianize Detailer wipe (Step 1) or Staticide wipe. Be careful not to scratch the imaging area when cleaning.

*IMPORTANT: Staticide wipes contain isopropanol which can cause eye irritation and dry skin. Wash your hands with soap and water after performing maintenance procedures. Refer to the Safety Data Sheet for more information.*

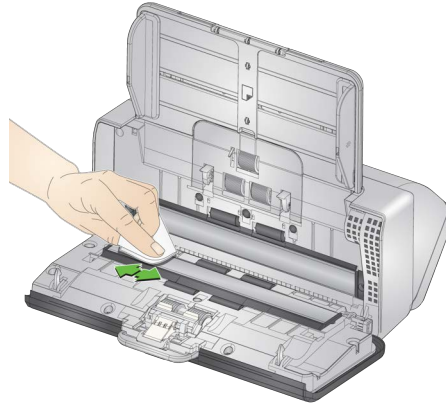

2. Wipe the upper and lower imaging area again using a Brillianize wipe (Step 2) or an almost dry Staticide wipe to remove any streaks.
3. When finished, close the scanner cover.

## Replacement procedures

Kodak Scanners use replaceable feed roller modules that can feed a wide range of document types, sizes and thicknesses. Operating environment, document type, the condition of pages being scanned, the frequency of cleaning paper path and tires, and not following the recommended schedule for changing the feed roller module can cause the life of consumables to vary. Change the feed roller module if you notice an increase in multiple feeds or stoppages, or a decrease in feeder performance that is not resolved by following the cleaning procedures.

### NOTES:

- Before replacing parts, disconnect the electrical power.
- Certain paper types (such as carbonless paper or newsprint), failure to clean regularly, and/or use of non-recommended cleaning solvents can shorten roller life.

## Replacing the separation roller

1. Open the scanner cover.
2. Remove the pre-separation pad by grasping it and pulling it straight out.



3. Grasp the separation roller and pull it straight out. Discard it.



4. Install the new separation roller by aligning the tab with the slot and snapping it into position.

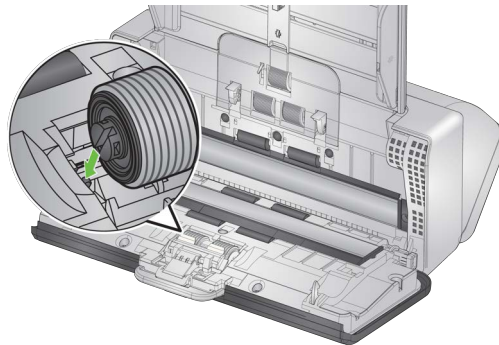

5. Re-install the pre-separation pad by aligning the slots with the holes on the pre-separation pad and snapping it into place.



6. Close the scanner cover.
7. Go to *Maintenance* on your scanner screen display and choose **Tires > Reset**. See “Scanner meters” on page 39.

## Replacing the pre-separation pad

1. Remove the pre-separation pad by grasping it and pulling it out of position.



2. Discard the worn pre-separation pad.
3. Install the new pre-separation pad by aligning the slots with the holes on the pre-separation pad and snapping it into place.

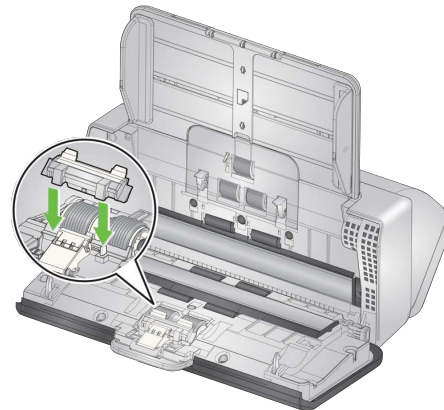

4. Go to *Maintenance* on your scanner screen display and choose **Separation pad > Reset**. See “Scanner meters” on page 39.



## Replacing the urging roller tire

An animation of this process is available at our on-line support for your scanner model, for instance:

[www.alarisworld.com/go/S2070support](http://www.alarisworld.com/go/S2070support)

[www.alarisworld.com/go/S2080wsupport](http://www.alarisworld.com/go/S2080wsupport)

1. Open the scanner cover.
2. Pull on the edge of the feed roller cover and lift it out of position.

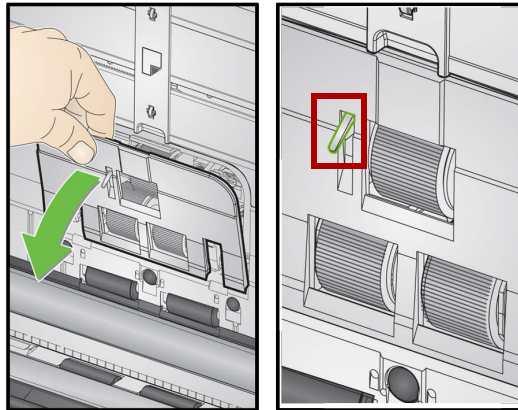

**NOTE:** Be careful not to damage the paper present sensor when removing or cleaning around the feed roller.

3. Remove the urging roller and replace the tire.



4. Reinstall the urging roller, aligning it correctly.

## Replacing the feed roller

1. Rotate the feed roller so the pin is aligned with the open slot. The roller rotates in only one direction. Use the white bracket at the end to rotate the roller. When the pin is aligned properly, lift the roller out of position.

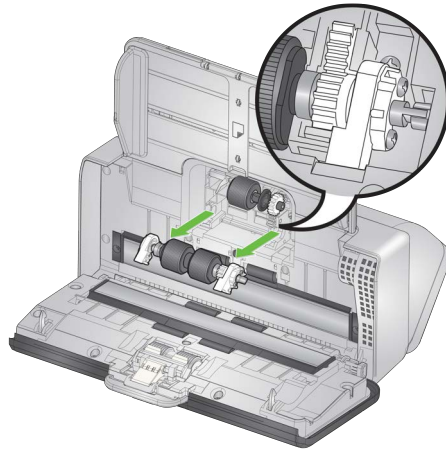

2. Discard the worn feed roller.
3. Install the new feed roller: align the pins with the open slots and fit the roller into position. Be sure the gears and brackets are aligned and the roller snaps into place.

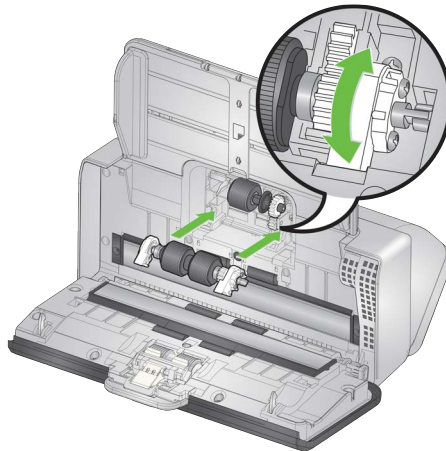

4. Reinstall the feed roller cover by positioning it around the paper present sensor, aligning the bottom edge of the cover with the scanner, and pushing it back into position until it snaps into place.

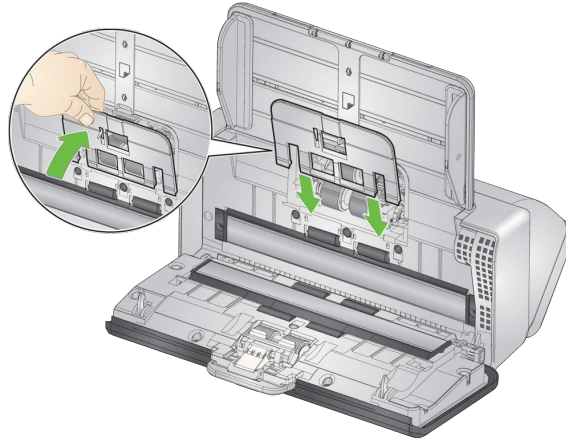

## Supplies and Consumables

### Customer Replaceable Parts and Accessories

For a full list of scanner cleaning supplies, consumables, accessories, and maintenance guidelines; refer to the support page for your scanner (below) and click on “Supplies.”

**S2040/S2050/S2070:** [www.alarisworld.com/go/S2000support](http://www.alarisworld.com/go/S2000support)

**S2060w/S2080w:** [www.alarisworld.com/go/S2000wsupport](http://www.alarisworld.com/go/S2000wsupport)

Contact your scanner supplier to order supplies.

## Updates

The drivers and internal firmware for your scanner can be updated by you. Find the latest driver and scanner firmware downloads here:

**S2040:** [www.alarisworld.com/go/S2040support](http://www.alarisworld.com/go/S2040support)

**S2050:** [www.alarisworld.com/go/S2050support](http://www.alarisworld.com/go/S2050support)

**S2070:** [www.alarisworld.com/go/S2070support](http://www.alarisworld.com/go/S2070support)

**S2060w:** [www.alarisworld.com/go/S2060wsupport](http://www.alarisworld.com/go/S2060wsupport)

**S2080w:** [www.alarisworld.com/go/S2080wsupport](http://www.alarisworld.com/go/S2080wsupport)

On your scanner screen, use the scanner **Settings > Information** display to see your scanner firmware version. Go to the **About** screen in the TWAIN or ISIS driver to find the driver version installed on your computer. More recent versions normally contain problem fixes and may also have feature enhancements.

---

# 5 Troubleshooting

## Scanner error indicators

A blinking power button indicates a scanner error or alert condition, which will be displayed on the scanner screen. A yellow alert needs your attention, e.g. if the scanner cover is open. A red alert is a critical error. If you can not correct the problem by following the guidance on the scanner screen, you may need to power-cycle the scanner. If the problem persists, call Technical Support.

NOTE: A slowly blinking power button with a blank scanner screen indicates the scanner is in low power mode. An error situation has a faster blink of the power button.

## Problem solving

If your scanner does not function as you expect, this section may help you resolve the situation.

## Scanner exception handling

The following user correctable error conditions will be reported on the scanner screen and will remain until you correct them:

- Paper jam — open the scanner cover and remove the jammed pages (see “Opening the scanner cover” on page 40).
- Multifeed — open the scanner cover and removed the multified pages. Choose one of the options presented on the scanner screen.
- Cover opened — close the scanner cover.
- Document protection warning — open the scanner cover and remove the page that caused the warning. If necessary to protect the page, use a document sleeve or scan on an attached flatbed. Otherwise replace the page in the input tray, adjust scanner settings as needed (see “Paper handling challenges and solutions” on page 29) and resume scanning.

## Self-help for problems

Use the chart below as a guide to help resolve the situation, before calling Technical Support. The self-help page for your scanner is also a good resource:

[www.alarisworld.com/go/S2070support](http://www.alarisworld.com/go/S2070support)

[www.alarisworld.com/go/S2080wsupport](http://www.alarisworld.com/go/S2080wsupport)

Problem	Possible Solution
Scanner will not scan/feed pages	<p>Check that:</p> <ul style="list-style-type: none"> <li>• the power adapter is plugged securely into the back of scanner and the wall outlet.</li> <li>• the wall outlet is not defective (call a licensed electrician).</li> <li>• the PC was restarted after installing the software.</li> <li>• page(s) are in contact with feed rollers and the paper present sensor.</li> <li>• scanner power light is on and the display screen indicates the scanner is ready.</li> </ul>
No images are being displayed	<p>If you are scanning one-sided pages, be sure the side you want to scan is facing the right way — for front side scanning, face down; for back side scanning, face up. For more information, see “Getting your pages ready to scan” on page 18.</p>
Pages are jamming or multiple pages are feeding	<p>To remove a jam:</p> <p><b>IMPORTANT: Do not pull the jammed page out of the scanner; open the scanner cover first.</b></p>  <p>The illustration shows a top-down view of a scanner with its cover open. A hand is shown reaching into the scanner bed to remove a page. Two green arrows indicate the direction of the page's movement: one pointing towards the hand and another pointing away from the scanner's rollers.</p> <ul style="list-style-type: none"> <li>• Remove any jammed page(s) from inside the scanner.</li> <li>• Close the scanner cover.</li> </ul> <p>To reduce future jamming or multifeeding, see “Paper handling challenges and solutions” on page 29.</p>
Paper is too wide for input tray	<ul style="list-style-type: none"> <li>• Move side guide lock to LTR setting, if it is on A4 setting.</li> <li>• For oversize pages, see “Oversize paper” on page 35.</li> </ul>
Images are not being cropped correctly	<ul style="list-style-type: none"> <li>• If the cropping options (<b>Automatically Detect and Straighten</b> or <b>Automatically Detect</b>) are enabled and your images are not being cropped correctly, clean the imaging area. See “Cleaning the imaging area” on page 46.</li> <li>• Straighten pages in the input tray.</li> </ul>

Roller marks appear on the paper after scanning	Clean the rollers. See the procedures in “4 Maintenance” on page 39.  Scanning pages with wet ink will cause ink to transfer to the tires, and from the tires to your pages. Do not scan pages unless the ink on them is dry.
Images have black background bleed-through	When scanning translucent paper, black bleed-through may appear on the image. To minimize this, adjust the Contrast and Brightness values or select <b>Draft (Fixed)</b> in TWAIN or <b>Fixed Processing</b> in ISIS to improve the image.
Red, green or blue streaks are running through a color photo	The scanner is dirty and needs to be cleaned. Refer to “Cleaning procedures” on page 40.
Images have speckles	Speckles happen because paper thickness is not uniform. See “Improving image quality” on page 37.
Scanner is running slow	<ul style="list-style-type: none"> <li>• Your PC may not meet the minimum requirements for the scanner. Refer to the page for your scanner model: <a href="http://www.alarisworld.com/go/S2000">www.alarisworld.com/go/S2000</a> <a href="http://www.alarisworld.com/go/S2000w">www.alarisworld.com/go/S2000w</a></li> <li>• The scanner is USB 3.1 Super Speed compliant. It is designed to operate with USB 3.1 or USB 2.0, but will function in a USB 1.1 port. If you are using a USB 1.1 connection, update your USB connection.</li> <li>• When scanning wirelessly, other network traffic can slow performance.</li> <li>• Several settings, such as active feeding and enhanced stacking, can slow the scanner. Experiment to find the settings that work best for you.</li> </ul>
“Length protection active” message shows on scanner screen	<ul style="list-style-type: none"> <li>• The combination of driver settings may result in a jam message when scanning occurs. If a jam message occurs, adjust one or more of these settings in the scanner driver. <ul style="list-style-type: none"> <li>–reduce the maximum document length</li> <li>–lower the image resolution</li> <li>–turn on compression</li> <li>–lower compression quality</li> <li>–change to simplex scanning</li> <li>–change the image type (color, gray scale, or black and white)</li> <li>–turn off Dual Stream</li> <li>–turn off Auto Color Detection</li> </ul> </li> </ul>

## Calibrations

Scanner multifeed calibration should be done only when Technical Support personnel tell you to calibrate.

The touch screen of the S2060w/S2080w scanners can be calibrated. Again, this calibration should be performed only if Technical Support personnel advise it and tell you how.

## Contacting Technical Support

1. Visit [www.alarisworld.com/go/IMsupport](http://www.alarisworld.com/go/IMsupport) to obtain the most current phone number for your country.
2. When calling, please have the following information ready:
  - A description of your problem.
  - The scanner model and serial number.
  - Computer configuration.
  - Scanning application you are using.



---

# Appendix A Regulatory Information

## Environmental information

- The *Kodak S2000* and *S2000w* Series Scanners are designed to meet worldwide environmental requirements.
- Guidelines are available for the disposal of consumable items that are replaced during maintenance or service; follow local regulations or contact Kodak Alaris locally for more information.
- Disposal of this equipment may be regulated due to environmental considerations. For disposal or recycling information, contact your local authorities or, in the USA, visit: [www.alarisworld.com/go/scannerrecycling](http://www.alarisworld.com/go/scannerrecycling).
- The product packaging is recyclable.
- Parts are designed for reuse and recycling.
- The *Kodak S2000* and *S2000w* Series Scanners are Energy Star compliant and are shipped from the factory with the default time set to 15 minutes.

## European Union



This symbol indicates that when the last user wishes to discard this product, it must be sent to appropriate facilities for recovery and recycling. Please contact your local Kodak Alaris representative or refer to [www.alarisworld.com/go/ehs](http://www.alarisworld.com/go/ehs) for additional information on the collection and recovery programs available for this product.

Please consult [www.alarisworld.com/go/ehs](http://www.alarisworld.com/go/ehs) for information about the presence of substances included on the candidate list according to article 59(1) of Regulation (EC) No. 1907/2006 (REACH).



## Product Disclosure Table - Kodak S2040/S2050/S2060w/S2070/S2080w Scanners

### 有毒有害物质或元素名称及含量标识表

Table of hazardous substances' name and concentration

部件名称 Component name	有毒有害物质或元素 hazardous substances' name					
	铅 (Pb)	汞 (Hg)	镉 (Cd)	六价铬 (Cr6+)	多溴联苯 (PBB)	多溴二苯醚 (PBDE)
适配器 (AC Adapter)	X	O	O	O	O	O
电路板 Circuit Board	X	O	O	O	O	O

**O:** 该有毒有害物质在该部件所有均质材料中的含量均在 SJ/T 11363-2006 规定的限量要求以下。  
**X:** 该有毒有害物质至少在该部件的某一均质材料中的含量超出 SJ/T 11363-2006 规定的限量要求。  
**O:** indicates hazardous substance concentration lower than MCV  
**X:** indicates hazardous substance concentration higher than MCV

环保使用期限 (EPUP)   
 在中国大陆，该值表示电子信息产品中含有的有毒有害物质或元素在正常使用的条件下不会发生外泄或突变，用户使用此产品不会对环境造成严重污染或对人身、财产造成严重损害的期限（以年计）。  
 该值根据操作说明中所规定的产品正常使用条件而定

**Environmental Protection Use Period (EPUP)**  
 In mainland China, this number indicates the time period (calculated by year) within which any hazardous substances present in the product are not expected to be released such that there is risk to human health, property, or the environment.  
 This value is assigned based on normal use of the product as described in the operating instructions.

**Taiwan:**

設備名稱：掃描器 · 型號 ( 型式 ) <i>Kodak S2040 Scanner,</i> Equipment name Type designation (Type) <i>Kodak S2050 Scanner, Kodak 2060w Scanner</i> <i>Kodak S2070 Scanner, Kodak S2080w Scanner</i>						
單元Unit	限用物質及其化學符號 Restricted substances and their chemical symbols					
	鉛 Lead (Pb)	汞 Mercury (Hg)	鎘 Cadmium (Cd)	六價鉻 Hexavalent chromium (Cr <sup>+6</sup> )	多溴聯苯 Polybrominated biphenyls (PBB)	多溴二苯醚 Polybrominated diphenyl ethers (PBDE)
外殼 Covers	○	○	○	○	○	○
電路板 Circuit Boards	-	○	○	○	○	○
掃描模組 Scan Module	-	○	○	○	○	○
取紙模組 Feed Module	○	○	○	○	○	○
配件 Accessories	-	○	○	○	○	○
備考1. “超出0.1 wt %” 及 “超出0.01 wt %” 係指限用物質之百分比含量超出百分比含量基準值。 Note 1 : “Exceeding 0.1 wt %” and “exceeding 0.01 wt %” indicate that the percentage content of the restricted substance exceeds the reference percentage value of presence condition. 備考2. “○” 係指該項限用物質之百分比含量未超出百分比含量基準值。 Note 2 : “○” indicates that the percentage content of the restricted substance does not exceed the percentage of reference value of presence. 備考3. “-” 係指該項限用物質為排除項目。 Note 3 : The “-” indicates that the restricted substance corresponds to the exemption.						

**EMC Statements for S2000 Series Scanners:**

**Notice to users in South Korea:** As this equipment has obtained EMC registration for household use, it can be used in an area including residential areas.

이 기기는 가정용으로 전자파적합등록을 한 기기로서 주거지역에서는 물론 모든 지역에서 사용할 수 있습니다.



**Notice to users in the US:** FCC: This equipment has been tested and found to comply with the limits for a Class B digital device, pursuant to Part 15 of the FCC Rules. These limits are designed to provide reasonable protection against harmful interference in a residential installation.

**Notice to users in Japan:** This is a Class B product based on the standard of the Voluntary Control Council for interference by information Technology Equipment (VCCI). If this is used near a radio or television receiver in a domestic environment, it may cause radio interference. Install and use the equipment according to the instruction manual.

この装置は、情報処理装置等電波障害自主規制協議会（VCCI）の基準に基づくクラスB情報技術装置です。この装置は、家庭環境で使用することを目的としていますが、この装置がラジオやテレビジョン受信機に近接して使用されると、受信障害を引き起こすことがあります。  
取扱説明書に従って正しい取り扱いをして下さい。

## EMC and Wireless Regulatory Statements for S2000w Series Scanners:

This device contains a preinstalled 2.4 GHz Wireless LAN module (Model: WN4615L)

**For Indoor Use:** This device is intended for indoor use only.

### Radio Frequency Exposure

**CAUTION:** When using this product, it should be installed and operated with a minimum distance of 7.9 in. (20 cm) for 2.4 GHz operations between the radiator and your body. This transmitter must not be collocated or operated in conjunction with any other antenna or transmitter. The radiated output power of this device is far below radio frequency exposure limits during normal operation.

**Notice to users in Argentina:** Acceso Inalambrico de Red  
CNC C-20571, CNC C-20572



**Notice to users in Brazil:** “Este equipamento opera em caráter secundário, isto é, não tem direito a proteção contra interferência prejudicial, mesmo de estações do mesmo tipo, e não pode causar interferência a sistemas operando em caráter primário.”(ANATEL 282/2001)

Anatel: 07890-17-02458

### Notice to users in Canada/Note à l'attention des utilisateurs canadiens:

**For Indoor Use.** This device complies with Industry Canada's licence-exempt RSSs. Operation is subject to the following two conditions:

- (1) This device may not cause interference; and
- (2) This device must accept any interference, including interference that may cause undesired operation of the device.

Utiliser à l'intérieur. Le présent appareil est conforme aux CNR d'Industrie Canada applicables aux appareils radio exempts de licence. L'exploitation est autorisée aux deux conditions suivantes :

- 1) l'appareil ne doit pas produire de brouillage;
- 2) l'appareil doit accepter tout brouillage radioélectrique subi, même si le brouillage est susceptible d'en compromettre le fonctionnement.

The radiated output power of this device is below the Industry Canada (IC) radio frequency exposure limits. This device has been evaluated for and shown compliant with the IC Radio Frequency (RF) Exposure limits. The device should be used in such a manner such that the potential for human contact during normal operation is minimized.

This device has been certified for use in Canada. Status of the listing in the Industry Canada's REL (Radio Equipment List) can be found at the following web address:

<http://www.ic.gc.ca/app/sitt/relet/srch/nwRdSrch.do?lang=eng>

La puissance rayonnée de sortie de cet appareil est inférieure aux limites d'exposition à la fréquence radio d'Industry Canada (IC). Cet appareil a été évalué et jugé conforme aux limites d'exposition à la fréquence radio (FR) d'IC. Cet appareil devrait être utilisé de manière à ce que le risque de contact humain au cours d'un fonctionnement normal soit réduit.

Cet appareil est homologué pour l'utilisation au Canada. Pour consulter l'entrée correspondant à l'appareil dans la liste d'équipement radio (REL - Radio Equipment List) d'Industry Canada, rendez-vous [https://sms-sgs.ic.gc.ca/equipmentSearch/searchRadioEquipments?execution=e1s1&lang=fr\\_CA](https://sms-sgs.ic.gc.ca/equipmentSearch/searchRadioEquipments?execution=e1s1&lang=fr_CA)

IC: 4491A-WN4615L

**Notice to users in China:** CCC; SRRC certification CMIIT ID: 2015DP0826



**Notice to users in EU/EFTA:** We, Kodak Alaris Inc. hereby declare that this equipment type (document scanner) is in compliance with Directive 2014/53/EU. The full text of the EU declaration of conformity is available at the following internet address: [www.alarisworld.com/go/ehs](http://www.alarisworld.com/go/ehs).



**Notice to users in Japan:** Japan Telec:  201-170777

■ Cautions prior to use of this product

When using this product in locations where use of radio waves is restricted (such as medical facilities, etc.), comply with the instructions from the location, and set the wireless switch to off. This product may affect electronic and medical equipment, or implanted medical devices (artificial pacemakers, etc.). Please take sufficient care, as this is a general characteristic of devices that utilize radio waves. For detailed information see the website of the Ministry of Internal Affairs and Communications.

<http://www.tele.soumu.go.jp/j/sys/ele/index.htm>

■ Cautions when using this product in a wireless LAN environment

- Please install this product and wireless access points/routers in locations with as few obstacles present as possible. The presence of obstacles that block radio waves (walls, metal sheets, etc.) may prevent communication or slow down communication speeds.
- Please use this product in a wireless LAN environment that you deem, at your responsibility, to be secure. Use in a non-secure wireless LAN environment may result in the disclosure of important data such as personal information to other parties. This company will bear no responsibility for any damage or disclosure of information occurring in a wireless LAN environment when this product is used in a non-secure environment or when security is breached using special methods. We would ask for your understanding on this matter.
- This product utilizes the 2.4GHz frequency band. This frequency band is utilized by microwave ovens, industrial/scientific/medical devices, factory production lines, and amateur radio stations.
  - Before using this product, check that there are not devices utilizing this frequency band close by.
  - In the unlikely event that radio frequency interference occurs when using this product, take measures required to avert jamming (change the channel used or the installation location, etc.), stop using the device, or set the wireless to "off" to stop radio wave emissions.
  - Additionally, when radio wave interference is causing difficulties, inquire at the distributor/store from which the product was purchased, or contact *Kodak* service and support.

This product contains wireless equipment that has received technical standards compliance certification based on the Radio Law, and features a certification label on the wireless equipment.

## 2.4 DS4 / OF4

The  listings on the label on the wireless equipment have the following meaning.

Listing	Content
2.4	This is a wireless device utilizing the 2.4 GHz (2400MHz) frequency band.
DS / OF	This device utilizes the DS-SS and OFDM modulation methods.
4	Assumed interference distance is 40 m or less.
	Able to utilize the full band, and to avoid bands used by mobile identification equipment.

- Use in the following circumstances may prevent communication or slow down communication speeds.
  - When this product and the wireless access point/router are separated by extreme distance.
  - When used in close proximity to devices that cause radio wave interference (microwave ovens, etc.).
  - When multiple wireless LAN access points are located close by, and using the same channel.

#### ■ The Radio Law

This product is equipped with wireless equipment that has received technical standards compliance certification based on the Radio Law. Disassembling this product or modifying its internal circuitry for use is prohibited by law, and may incur penalties for the customer. Additionally, this company bears no responsibility for any injuries occurring due to disassembly or modification of this product. We would ask for your understanding on this matter.

**Notice to users in Mexico:** “Este equipo opera a título secundario, consecuentemente, debe aceptar interferencias perjudiciales incluyendo equipos de la misma clase y puede no causar interferencias a sistemas operando a título primario.”

IFETEL: 223

**Notice to users in Singapore:** Complies with IDA Standards: (DA106764)

**Notice to users in South Africa:** ICASA APPROVED: TA-2017/1931

**Notice to users in South Korea:**

해당 무선설비는 전파혼신 가능성이 있으므로 인명안전과 관련된 서비스는 할 수 없음

**Notice to users in Taiwan:**

台灣: 國家通訊傳播委員會

低功率電波輻射性電機管理辦法

第十二條經型式認證合格之低功率射頻電機，非經許可，公司、商號或使用者均不得擅自變更頻率、加大功率或變更原設計之特性及功能。

第十四條低功率射頻電機之使用不得影響飛航安全及干擾合法通信；經發

現有干擾現象時，應立即停用，並改善至無干擾時方得繼續使用。前項合法通信，指依電信法規定作業之無線電通信。低功率射頻電機須忍受合法通信或工業、科學及醫療用電波輻射性電機設備之干擾。

CCAF17LP0860T6

**Notice to users in Thailand:** This wireless communication equipment has the electromagnetic field strength in compliance with the Safety Standard for the Use of Wireless Communication Devices on Human Health announced by the National Telecommunications Commission.



**Notice to users in the US:** FCC: This equipment has been tested and found to comply with the limits for a Class B digital device, pursuant to Part 15 of the FCC Rules. These limits are designed to provide reasonable protection against harmful interference in a residential installation.

This equipment generates, uses, and can radiate radio frequency energy and, if not installed or used in accordance with the instructions, may cause harmful interference to radio communications. However, there is no guarantee that interference will not occur in a particular installation.

If this equipment does cause harmful interference to radio or television reception, which can be determined by turning the equipment off and on, the user is encouraged to try to correct the interference by one or more of the following measures:

- 1) reorient or relocate the receiving antenna;
- 2) increase the separation between the equipment and the receiver;
- 3) connect the equipment to an outlet on a circuit different from that to which the receiver is connected;
- 4) consult the dealer or an experienced radio/TV technician for additional suggestions.

Any changes or modifications not expressly approved by the party responsible for compliance could void the user's authority to operate the equipment. Where shielded interface cables have been provided with the product or specified additional components or accessories elsewhere defined to be used with the installation of the product, they must be used in order to ensure compliance with FCC regulation.

FCC ID: PPQ-WN4615L

**Networking Performance Statement, notice to users:** It should be understood that wireless networks and, therefore, system performance, are impacted negatively by a number of factors including: interference from other RF sources; physical obstructions; distance between devices; and relative location. Competing network traffic will additionally degrade performance for both wired and wireless interfaces.





---

# Appendix B Warranty — US and Canada only

Congratulations on the purchase of a *Kodak Scanner*. *Kodak Scanners* are designed to provide end users with the highest performance and reliability. All *Kodak Scanners* are covered by the following Limited Warranty.

## Limited Warranty for *Kodak Scanners*

Kodak Alaris Inc. provides the following Limited Warranty on *Kodak Scanners* (excluding spare parts and consumables) distributed by Kodak Alaris or through Kodak Alaris' authorized distribution channels:

Kodak Alaris Inc. warrants that a *Kodak Scanner*, from the time of sale through the Limited Warranty period applicable to the Product, will be free of defects in materials or workmanship and will conform to the performance specifications applicable for the particular *Kodak Scanner*.

All *Kodak Scanners* are subject to the Warranty Exclusions described below. A *Kodak Scanner* found to be defective or which does not conform to the product specifications will be repaired or replaced with new or refurbished product at Kodak Alaris' option.

Purchasers may determine the applicable Limited Warranty period for the *Kodak Scanners* purchased by visiting [www.alarisworld.com/go/imsupport](http://www.alarisworld.com/go/imsupport).

Proof of purchase is required to demonstrate eligibility for warranty service.

## Warranty exclusions

Kodak Alaris' Limited Warranty does not apply to a *Kodak Scanner* that has been subjected to physical damage after purchase, caused, for example, by casualty, accident, acts of God or transportation, including (a) by a failure to properly package and ship the Scanner back to Kodak Alaris for warranty service in accordance with Kodak Alaris' then current Packaging and Shipping Guidelines, including failure to replace the shipping restraint prior to shipping, or by a failure to remove the shipping restraint prior to use; (b) resulting from the user's installation, system integration, programming, re-installation of user operating systems or applications software, systems engineering, relocation, reconstruction of data, or removal of the product or any component (including breakage of a connector, cover, glass, pins, trays or seal); (c) from service, modification or repair not performed by Kodak Alaris or a service provider authorized by Kodak Alaris or by tampering, use of counterfeit or other non-Kodak Alaris components, assemblies, accessories, or modules; (d) by misuse, unreasonable handling or maintenance, mistreatment, operator error, failure to provide proper supervision or maintenance, including use of cleaning products or other accessories not approved by Kodak Alaris or use in contravention of recommended procedures or specifications; (e) by environmental conditions (such as excessive heat or other unsuitable physical operating environment), corrosion, staining, electrical work external to the product or failure to provide electro-static discharge (ESD) protection; (f) by failure to install firmware updates or releases available for the product and (g) by such other supplemental exclusions published from time to time online at [www.alarisworld.com/go/imsupport](http://www.alarisworld.com/go/imsupport).

Kodak Alaris provides no Limited Warranty for products purchased from countries other than the United State and Canada. Purchasers of products from foreign distribution channels must seek warranty coverage, if any, through the original source of purchase.

Kodak Alaris provides no Limited Warranty for products that are purchased as part of a third party manufacturer's product, computer system or other electronic device.

Any warranty for these products is provided by the OEM (Original Equipment Manufacturer) as part of that manufacturer's product or system.

The replacement product assumes the remainder of the Limited Warranty period applicable to the defective product or thirty (30) days, whichever is longer.

## Installation Warning and Disclaimer

KODAK ALARIS WILL NOT BE RESPONSIBLE FOR ANY CONSEQUENTIAL OR INCIDENTAL DAMAGES RESULTING FROM THE SALE, INSTALLATION, USE, SERVICING OR IMPROPER FUNCTIONING OF THIS PRODUCT, REGARDLESS OF THE CAUSE. SUCH DAMAGES FOR WHICH KODAK ALARIS WILL NOT BE RESPONSIBLE, INCLUDE, BUT ARE NOT LIMITED TO, LOSS OF REVENUE OR PROFIT, LOSS OF DATA, DOWNTIME COSTS, LOSS OF USE OF THE PRODUCT, COST OF ANY SUBSTITUTE PRODUCT, FACILITIES OR SERVICES OR CLAIMS OF CUSTOMERS FOR SUCH DAMAGES.

If there is any conflict between other sections of this appendix and the Limited Warranty, the terms of the Limited Warranty prevail.

### **How to obtain Limited Warranty service**

*Kodak* Scanners are supplied with information on unpacking, setup, installation and operation. Careful reading of the User's Guide will answer most of the technical questions the end user might have regarding proper installation, operation and maintenance of the product. However, should additional technical support be required, you may visit our website at: [www.alarisworld.com/go/imsupport](http://www.alarisworld.com/go/imsupport) or contact: Kodak Alaris' Response Center: **(800) 822-1414**

The Response Center is available Monday – Friday (excluding Kodak Alaris holidays) 8 a.m. to 5 p.m. EST.

Before placing the call, the eligible purchaser should have the *Kodak* Scanner model number, part number, serial number and proof of purchase available. The eligible purchaser should also be prepared to provide a description of the problem.

Response Center personnel will assist the end user in resolving the problem over the phone. The end user may be asked to run some simple, self-diagnostic tests and report the resulting status and error code messages. This will assist the Response Center in determining if the problem is the *Kodak* Scanner or another component and if the problem can be resolved over the phone. If the Response Center determines a hardware problem exists that is covered either under the Limited Warranty or a purchased Maintenance Agreement, a Return Material Authorization Number (RMA) will be assigned as needed, a service request will be initiated and repair or replacement procedures will follow.

### **Packaging and shipping guidelines**

Purchaser must ship all warranty returns in a method that guarantees full protection of the product from shipping damage. Failure to do so will void the *Kodak* Scanner warranty. Kodak Alaris advises the purchaser to keep the original box and packing materials for storing or shipping. Kodak Alaris is not responsible for issues related to shipping damage. The purchaser must return only the *Kodak* Scanner. Prior to shipment, purchaser must remove and retain all "add-on" items, (i.e. adapters, cables, software, manuals, etc.). Kodak Alaris accepts no responsibility for these items and they will not be returned with the repaired or replacement *Kodak* Scanner. All products should be returned to Kodak Alaris in the original shipping container, or an authorized packaging box for the units being returned. Purchaser must install the shipping restraint before the *Kodak* Scanner is shipped. When the original packaging is not available, contact Kodak Alaris' Response Center at (800) 822-1414 for part numbers and replacement packaging ordering information.

### **Return procedure**

Eligible purchasers seeking services for *Kodak* Scanners covered under this Limited Warranty must obtain a Return Material Authorization Number ("RMA") by calling (800) 822-1414 and within ten (10) business days from the date of issuance of the RMA must return the *Kodak* Scanner to the address designated in the RMA at the end user's own expense and risk, in compliance with Kodak Alaris' current Packaging and Shipping Guidelines.

Any defective products or parts replaced by Kodak Alaris become the property of Kodak Alaris.

### **Customer responsibility**

BY REQUESTING SERVICE, THE ELIGIBLE PURCHASER ACKNOWLEDGES THE TERMS OF THE LIMITED WARRANTY, INCLUDING THE DISCLAIMER AND LIMITATION OF LIABILITY PROVISIONS. PRIOR TO SEEKING SERVICE, THE END USER MUST BACK-UP ANY DATA OR FILES THAT MAY BECOME DAMAGED OR LOST. KODAK ALARIS IS, WITHOUT LIMITATION, NOT RESPONSIBLE FOR LOST OR DAMAGED DATA OR FILES.

### **Warranty Service descriptions**

Kodak Alaris offers a range of service programs to support its Limited Warranty and to assist with the use and care of the *Kodak* Scanner ("Service Methods"). A *Kodak* Scanner represents an important investment. *Kodak* Scanners provide the productivity needed to stay competitive. The sudden loss of this productivity, even temporarily, could seriously affect the ability to meet commitments. Downtime can be very expensive, not just in the cost of the repair but also in time lost. To help alleviate these problems, Kodak Alaris may use one of the service methods listed below, depending upon product type, in providing service under its Limited Warranty.

Information about the product, including warranty, service program information, and restrictions, can be obtained online at [www.alarisworld.com/go/imsupport](http://www.alarisworld.com/go/imsupport).

To avoid service delays, Kodak Alaris urges end users to complete the Limited Warranty Registration process online at [www.alarisworld.com/go/imsupport](http://www.alarisworld.com/go/imsupport).

Product model and product serial number are required to complete the registration process.

Kodak Alaris also provides a variety of service programs that may be purchased to assist with the use and care of the *Kodak* Scanner.

Kodak Alaris is committed to providing its customers with quality, performance, reliability and service under the Limited Warranty.

We expect to have a supply of spare parts and consumables for at least 5 years after product manufacture has been discontinued.

**Advanced Unit Replacement (AUR)**

AUR may be one of the easiest and most comprehensive service offerings in the industry. In the unlikely event of a product defect, for eligible purchases of certain *Kodak* scanners, Kodak Alaris will replace that product within two business days.

The AUR provides advance replacement on specific failed or broken *Kodak* scanners. If Kodak Alaris determines a product is not operating consistently within manufacturer's specifications, Kodak Alaris will provide next day AUR subject to availability of courier service. The replacement product will perform at the minimum specifications of the current product but may not be the exact make and model. The replacement product may be a refurbished unit. When AUR support is necessary, Kodak Alaris will ship the replacement unit to Customer's location, transportation prepaid. Upon delivery of a replacement unit, Customer must remove all options and accessories (which include power cord, documentation, etc.) that are not covered by the Limited Warranty, then place the entire malfunctioning unit in the shipping case, apply the enclosed labels and call the carrier for pickup within 5 business days after receiving the AUR. Kodak Alaris will pay the return transportation charges. If parts are missing from the returned unit, Customer may be charged for the parts at prevailing per call rates. If the Customer has not returned the malfunctioning unit within 10 business days, Customer will be invoiced the list price of the unit and becomes responsible for such charge.

**Depot service**

If the *Kodak* Scanner is not eligible for AUR or On-Site Service, an eligible purchaser may utilize our Depot Repair Service. The eligible purchaser will be instructed to ship the product to the nearest authorized Depot Repair Center. Product must be shipped at the eligible purchaser's risk and expense to the repair center. Before the product is returned to the repair center, be sure to remove all options and accessories (which include power cord, documentation, etc.) not covered by the Limited Warranty. All products should be returned to Kodak Alaris in the original shipping container, or in a recommended packing box. The *Kodak* Scanner must have the shipping restraint installed before it is shipped. When the original packaging is not available, contact Kodak Alaris' Response Center at (800) 822-1414, for ordering information. Eligible purchasers seeking services for *Kodak* Scanners must obtain a Return Material Authorization number ("RMA") by calling (800) 822-1414, and within ten (10) business days from the date of issuance of the RMA must return the *Kodak* Scanner to the address designated in the RMA at the end user's own expense and risk. The Return Material Authorization Number ("RMA") must be clearly marked on the outside of the box to ensure proper receipt and credit of the defective product.

Upon receipt of the product, the repair center will repair product within ten (10) business days. The repaired product will be shipped back two-day express mail at no expense to the eligible purchaser.

**Important restrictions**

**Eligibility:** The Advance Exchange Program and the Depot Repair Service are available to eligible purchasers in the fifty (50) United States for products purchased from authorized distributors of Kodak Alaris. The *Kodak* Scanner will be ineligible for any service under warranty if the product falls under any of Kodak Alaris' then-current Warranty Exclusions, including a purchaser's failure to return defective products to Kodak Alaris in compliance with Kodak Alaris' then current Packaging and Shipping Guidelines. Persons are only considered "eligible purchasers" or "end users" if they originally purchased the *Kodak* Scanner for their own personal or business use, and not for resale.

**Consumables:** Consumables are items that wear out under normal use and must be replaced by the end user as needed. Consumables, supplies, other expendable items and those items identified as being the user's responsibility in the User's Guide are not covered under the Limited Warranty.

Any defective products or parts replaced by Kodak Alaris become the property of Kodak Alaris.

**Contacting Kodak Alaris**

For Information on *Kodak* Scanners:

Website: [www.alarisworld.com/go/IM](http://www.alarisworld.com/go/IM)

For U.S. contact Technical Support by telephone:

Telephone technical support is available Monday-Friday between the hours of 5 a.m. to 5 p.m. excluding Kodak Alaris holidays.

Phone: (800) 822-1414

For technical documentation and FAQs available 24 hours a day:

Website: [www.alarisworld.com/go/IM](http://www.alarisworld.com/go/IM)

For Service Program information

Website: [www.alarisworld.com](http://www.alarisworld.com)

Phone: (800) 822-1414



